

User manual
CIFX HPCIE90-RE\F
PC card Half-Mini PCI Express Real-Time-Ethernet Slave



Hilscher Gesellschaft für Systemautomation mbH
www.hilscher.com

DOC210802UM02EN | Revision 2 | English | 2024-01 | Released | Public

Table of contents

1	Introduction	4
1.1	About the user manual	4
1.2	List of revisions	4
2	Devices and accessories	5
2.1	Basic card CIFX HPCI90	6
2.2	Detached network interface AIFX-V2-RE.....	7
2.3	Product software	7
2.4	Revision or version status of hardware and software	8
2.5	Device label with matrix code.....	9
3	Safety	10
3.1	General note	10
3.2	Intended use	10
3.3	Personnel qualification	10
3.4	Safety messages.....	11
3.4.1	Hazardous voltage, electric shock	11
3.4.2	Personal injury, device damage due to hot swap/hot plug.....	11
3.5	Property damage.....	12
3.5.1	Excessive supply voltage	12
3.5.2	Excessive signaling voltage	12
3.5.3	Electrostatic sensitive devices	12
3.5.4	Fracture of the basic card	13
3.5.5	Power drop during write and delete accesses in the file system	13
3.5.6	Exceeding the maximum number of permitted write and delete accesses	13
3.6	Information and data security.....	13
4	Installing the hardware	14
4.1	System Requirements.....	14
4.2	Requirements for operation.....	16
4.3	Overview installation and firmware download	17
4.4	Installation warnings.....	18
4.5	Installing the hardware	20
4.6	Loading firmware and configuration in the device or making an update	21
4.7	Hints for problem solving.....	22
4.8	Uninstalling the hardware.....	23
4.9	Disposal and recycling of waste electronic equipment.....	24
5	Diagnosis with LEDs	25
5.1	Overview	25
5.2	System LED	26
5.3	EtherCAT Slave	27
5.4	EtherNet/IP Adapter (V3/5)	29
5.5	OpenModbusTCP	31
5.6	POWERLINK Controlled Node.....	32

5.7	PROFINET IO-Device	34
6	Connectors	35
6.1	Ethernet RJ45 socket	35
6.2	Data of the Ethernet connection	36
6.3	Usability of hubs and switches	36
6.4	Cable connector Ethernet X801 on CIFX HPCIE90	37
6.5	Cable connector Ethernet X1 on AIFX-V2-RE	38
6.6	Mini PCI Express Bus (H2)	39
7	Technical data	41
7.1	PC card CIFX HPCIE90-RE\F	41
7.2	PCI identifiers on the Mini PCI Express bus	42
7.3	AIFX-V2-RE	43
7.4	Communication protocols	44
7.4.1	EtherCAT Slave	44
7.4.2	EtherNet/IP Adapter	45
7.4.3	Open Modbus/TCP	47
7.4.4	POWERLINK Controlled Node	47
7.4.5	PROFINET IO-Device	48
8	Dimensions	50
8.1	Tolerances of PCB dimensions	50
8.2	Dimensions CIFX HPCIE90	51
8.3	Dimensions AIFX-V2-RE	52
9	Appendix	53
9.1	FCC compliance	53
9.2	References	53
9.3	Conventions in this manual	55
9.4	Legal notes	56
9.5	Registered trademarks	60
	Glossary	64
	Contacts	67

1 Introduction

1.1 About the user manual

This user manual for your PC card CIFX HPCI90-RE\F Real-Time Ethernet informs you about the topics:

- Hardware description,
- installation of the hardware and
- firmware download.

Further information on how to download the firmware, as well as descriptions about configuration and diagnosis of your device can be found in separate operating instruction manuals.

1.2 List of revisions

Index	Date	Changes
1	22-03-10	All sections created.
2	24-01-22	<p>Hardware revision update: basic card CIFX HPCI90 (revision 4). Connection of the shielding to earth (ground, pin 1) when connecting the foil cables. Warning of breaking the basic card due to pressure. POWERLINK Controlled Node protocol added.</p> <p>Sections <i>Basic card CIFX HPCI90</i> [▶ page 6] and <i>Detached network interface AIFX-V2-RE</i> [▶ page 7]: Pin 1 and pin 20 indicated. Sections <i>Revision or version status of hardware and software</i> [▶ page 8] and <i>Product software</i> [▶ page 7] updated. Chapter <i>Safety</i> [▶ page 10] updated. Sections <i>Overview installation and firmware download</i> [▶ page 17], <i>Installing the hardware</i> [▶ page 14] and <i>Uninstalling the hardware</i> [▶ page 23] updated. Section <i>Disposal and recycling of waste electronic equipment</i> [▶ page 24] updated. Section <i>PC card CIFX HPCI90-RE\F</i> [▶ page 41], <i>EtherCAT Slave</i> [▶ page 44], <i>EtherNet/IP Adapter</i> [▶ page 45] and <i>PROFINET IO-Device</i> [▶ page 48] updated. Section <i>Dimensions CIFX HPCI90</i> [▶ page 51] and <i>Dimensions AIFX-V2-RE</i> [▶ page 52]: Specification of pin 1 and pin 20.</p>

Table 1: List of revisions

2 Devices and accessories

The PC card CIFX HPCIE90-RE\F is a communication interface from Hilscher based on the communication controller netX 90 and consists of a basic card that is equipped with a detached network interface.

PC card	Description of the basic card	Accessories
CIFX HPCIE90-RE\F	Communication Interface Mini PCIe half-size: CIFX HPCIE90	Detached network interface Ethernet: AIFX-V2-RE
	Type (according to the PCI Express Mini Card specification): PCI Express half-Mini Card (H2)	
	Mini PCI Express slot (3.3 V)	

Table 2: PC card CIFX HPCIE90-RE\F

Product family	Card format and type	netX	Network	Cable
CIFX	HPCIE	90	-RE	\F

Table 3: Meaning of the device name

The use refers exclusively to Slave systems. Depending on the firmware loaded, the PC cards cifX perform the protocol-specific communication of the selected Real-Time Ethernet system. Data is exchanged between the connected Ethernet devices and the PC or connection device via the Dual-Port Memory.

2.1 Basic card CIFX HPCI E90

In the following illustration with legend you can recognize the device elements significant for installation and operation each by a number.

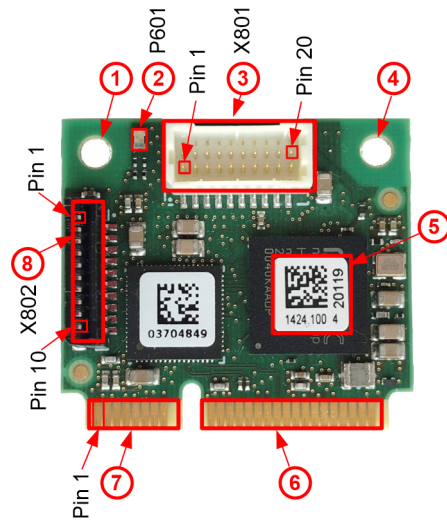

Figure 1: Basic card CIFX HPCI E90 (Revision 4)

No.	Description
(1), (4)	Holes for mounting the PC card
(2)	System LED (yellow/green)
(3)	Cable connector Ethernet (X801, 20-pin)
(5)	Matrix label
(6)	Mini PCI Express bus, pin 17 to pin 52 (top: Pin 17 ... 51, bottom: Pin 18 ... pin 52)
(7)	Mini PCI Express bus, pin 1 to pin 16 (top: Pin 1 ... 15, bottom: Pin 2 ... pin 16)
(8)	Cable connector fieldbus (X802, 10-pin)

Table 4: Legend for the basic card CIFX HPCI E90

2.2 Detached network interface AIFX-V2-RE

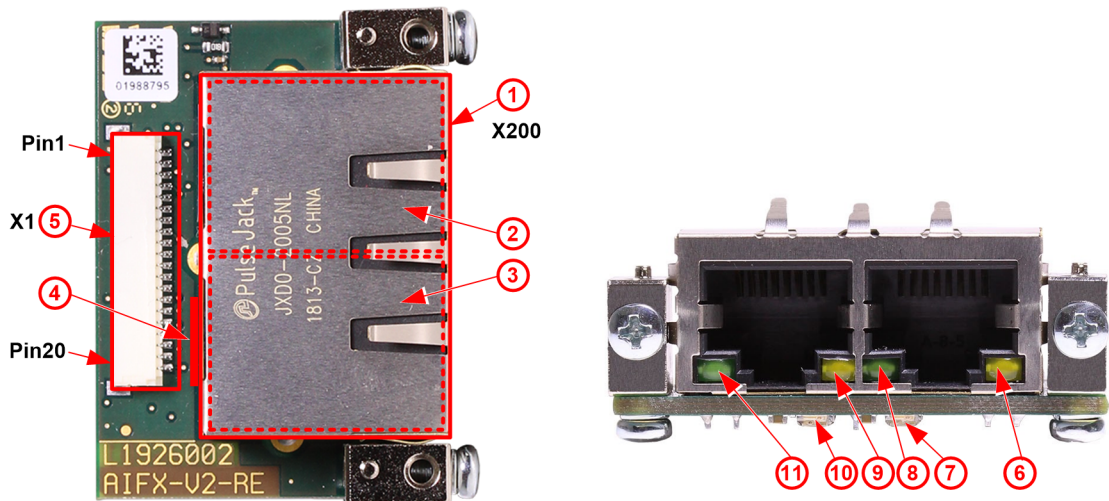

Figure 2: Detached network interface AIFX-V2-RE (revision 2)

No.	Description
(1)	2 x Ethernet RJ45 socket connector (X200)
(2)	Channel 1 (CH1)
(3)	Channel 0 (CH0)
(4)	Mini matrix label (reverse side X200)
(5)	Cable connector Ethernet (X1, 20 pin)
(6)	Ethernet LED yellow, channel 1 (CH1)
(7)	Communication status LED COM1 (red/green)
(8)	Ethernet LED green, channel 1 (CH1)
(9)	Ethernet LED yellow, channel 0 (CH0)
(10)	Communication status LED COM0 (red/green)
(11)	Ethernet LED green, channel 0 (CH0)

Table 5: Legend on the detached network interface AIFX-V2-RE



Important:

Note that the detached network interface Ethernet AIFX-V2-RE especially is designed for netX 90-based devices and exclusively works together with them. In contrast, the detached network interface Ethernet AIFX-RE is only suitable for netX 100-based devices.

2.3 Product software

All the information and software you need for your product can be downloaded free of charge at the web-link

<https://hilscher.atlassian.net/wiki/spaces/CARDS/overview>.

- Select the link for the current release for the Download Package Communication Solution 90.

After the download, you can start commissioning and configuring your device immediately.

- Check our website regularly for software updates for your product.

2.4 Revision or version status of hardware and software

The hardware revisions listed below, as well as the driver, software and firmware versions belong together functionally. If a hardware installation is available, the driver and the firmware must be updated according to these specifications.

Device name	Description	Part no.	Hardware revision
CIFX HPCIE90-RE\F	Basic card CIFX HPCIE90 and AIFX-V2-RE	1424.101	-
CIFX HPCIE90	Communication Interface Mini PCIe half-size (basic card)	1424.100	4
AIFX-V2-RE	Detached network interface Ethernet	2801.100	2

Table 6: Hardware revisions

Driver and software	Name	Version
Device driver	cifX Device Driver	2.3 or higher
Software to download the firmware	Device Explorer	1.3
Configuration software	Communication Studio	1.4

Table 7: Driver and software versions

Protocol	File name	Firmware version
EtherCAT Slave	X090F001.nxi	5.3
EtherNet/IP Adapter	X090H001.nxi	5.3
Open Modbus/TCP	X090L001.nxi	5.2
POWERLINK Controlled Node	X090K001.nxi	5.1
PROFINET IO-Device	X090D001.nxi	5.5

Table 8: Firmware version and file names for permitted protocols



Note:

Unless otherwise stated, the firmware version in this manual is the same as the stack version.

2.5 Device label with matrix code

You can identify your device by means of the device label.

**Note:**

The position of the device label on your device is indicated in the device overview.

The device label consists of a matrix code and the information contained therein in plain text.

The 2D code (Data Matrix Code) contains the following information:

- ① Part number: 1234.567
- ② Hardware revision: 1
- ③ Serial number: 20000

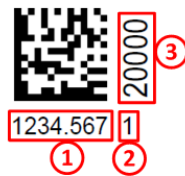

Figure 3: Example 2D label

3 Safety

3.1 General note

The documentation in the form of a user manual, an operating instruction manual or other manual types, as well as the accompanying texts, have been created for the use of the products by qualified personnel. When using the products, all Safety Messages, Integrated Safety Messages, Property Damage Messages and all valid legal regulations must be obeyed. Technical knowledge is presumed. The user has to assure that all legal regulations are obeyed.

3.2 Intended use

Depending on the loaded firmware the PC card CIFX HPCIE90-RE\F can be used to implement a corresponding Real-Time Ethernet system. Information on the permissible Real-Time Ethernet systems can be found in the section *Revision or version status of hardware and software* [► page 8].

3.3 Personnel qualification

The PC card may only be installed, configured, operated or uninstalled by qualified personnel. Job-specific technical skills for people professionally working with electricity must be present concerning the following topics:

- Safety and health at work
- Mounting and connecting of electrical equipment
- Measurement and Analysis of electrical functions and systems
- Evaluation of the safety of electrical systems and equipment
- Installing and configuring IT systems

3.4 Safety messages

3.4.1 Hazardous voltage, electric shock

Danger to life or risk of injury by electric shock may occur if you open the housing of your PC (or connection device) to install your PC card.

- **Hazardous voltages** are present in the PC (or connection device) for mounting. Always read and observe the safety instructions of the PC manufacturer before installation.
- First disconnect the power plug of the PC (or connection device), before opening the housing.
- Make sure that the power supply is off at the PC (or connection device).
- Only then open the housing and install or remove the PC card.

3.4.2 Personal injury, device damage due to hot swap/hot plug

The PC card is not designed or intended for a hot-swap or hot-plug connection. Performing hot-swap or hot-plug may pose a hazard to the PC card, the system platform and the person performing the action.

3.5 Property damage

3.5.1 Excessive supply voltage

The PC card may only be operated with the prescribed supply voltage, which corresponds to the tolerances specified in this manual. The limits of the permitted range must not be exceeded.

Device damage, malfunctions

- If the supply voltage is above the specified upper limit, this can lead to serious damage to the PC card!
- If the supply voltage is below the specified lower limit, malfunctions of the PC card may occur.

3.5.2 Excessive signaling voltage

All I/O signal pins on the PC card tolerate only the specified signal voltage, as specified in this manual.

Device destruction

Operating your PC card at a signal voltage that exceeds the specified signal voltage can cause serious damage to the PC card!

3.5.3 Electrostatic sensitive devices

This equipment is sensitive to electrostatic discharge which cause internal damage and affect normal operation. Therefore adhere to the necessary safety precautions for components that are vulnerable with electrostatic discharge if you install or replace your device. Follow the guidelines listed hereafter when you handle this equipment:

- Touch a grounded object to discharge potential static.
- Wear an approved grounding wriststrap.
- Do not touch connectors or pins on the PC card.
- Do not touch circuit components inside the equipment.
- If available, use a static-safe workstation.
- When not in use, store the equipment in appropriate static-safe packaging.

3.5.4 Fracture of the basic card

Do not exert any unnecessary force to the basic card, to prevent the circuit board from breaking.

During *installation* always adhere to the step sequence:

1. First plug the cable into the cable connector on the basic card.
2. Then insert the basic card into the Mini PCI Express slot and fasten it.

During *uninstallation* always adhere to the step sequence:

1. First unscrew the basic card and remove it from the Mini PCI Express slot.
2. Then pull the cable out of the cable connector on the basic card.

3.5.5 Power drop during write and delete accesses in the file system

The FAT file system in the netX firmware is subject to certain limitations in its operation. Write and delete accesses in the file system (firmware update, configuration download etc.) can destroy the FAT (File Allocation Table) if the accesses cannot be completed if the power drops. Without a proper FAT, a firmware may not be found and cannot be started.

- Make sure that the power supply of the device does not drop during write and delete accesses in the file system (firmware update, configuration download etc.).

3.5.6 Exceeding the maximum number of permitted write and delete accesses

This device uses a serial flash chip to store remanent data such as firmware storage, configuration storage, etc. This device allows a maximum of 100,000 write/delete accesses that are sufficient for standard operation of the device. However, writing/deleting the chip excessively (e.g. changing the configuration or changing the name of station) leads to the maximum number of permitted write/delete accesses being exceeded and to device damage. For example, if the configuration is changed once an hour, the maximum number is reached after 11.5 years. If the configuration is changed even more frequently, for example once a minute, the maximum number is reached after approx. 69 days.

Avoid exceeding the maximum permitted write/delete accesses by writing too often.

3.6 Information and data security

Take all usual measures for information and data security, in particular, for PC cards with Ethernet technology. Hilscher explicitly points out that a device with access to a public network (Internet) must be installed behind a firewall or only be accessible via a secure connection such as an encrypted VPN connection. Otherwise, the integrity of the device, its data, the application or system section is not safeguarded.

Hilscher cannot assume any warranty or liability for damage due to neglected security measures or incorrect installation.

4 Installing the hardware

4.1 System Requirements

To install your cifX PC cards, you need a PC or a connection device with a Mini PCI Express slot (host interface) for mounting the PC card.

Host interface

PC card	Type	Supply voltage (1)	Power consumption (2)	Signal voltage (3)
CIFX HPCIE90-RE\F	Mini PCI Express slot (3.3 V)	+3.3 VDC -5% / +9%	See section <i>PC card CIFX HPCIE90-RE\F</i> [▶ page 41].	PCIe compatible

Table 9: Host interface requirements

Comments:

(1) Required or permissible supply voltage

(2) Typical current consumption at 3.3 V. The typical current consumption depends on the type of PC card. To ensure compatibility between different systems, it is recommended to supply a maximum of 1 A (at +3.3 VDC -5% / +9%).

(3) Required or tolerated signal voltage at the I/O signal pins on the PCIe bus of the PC card

Host system

For communication via PCI Express, the host system may only use the standard mode with a length of 5 bits for identification (tag field length). In the extended mode, i.e. at lengths of 8 bits for identification of the PCI-Express communication, communication errors occur. Note the errata "CIFX M223090AE and CIFX HPCIE90" (Hilscher DOC-ID DOC220201ERR02EN) and the solutions and workarounds given therein. The reference is listed in the section *References* [▶ page 53].

Mounting the basic card

In order to attach the basic card, the board on which the Mini PCI Express slot is located must have a mounting option. This can consist of two snap hooks or a clip for snapping the basic card into place or two holes for screwing the basic card onto the board. The dimensions for the positioning of the snap hooks, clip or screw holes can be found in the dimension drawing for the basic card provided in this manual.

Operating system

For Device Explorer or Communication Studio: Windows® 10

Component heights

- The component height on the top of the basic card CIFX HPCIE90 exceeds the height of 1.5 mm specified by the standard, because the height of the cable connectors (Ethernet X801, or fieldbus X802), including the cable, is approximately 8.5 mm above the circuit board.
- The component height on the bottom of the basic card CIFX HPCIE90 complies with the standard specifications.

Panel dimensioning

- **Panel cut-outs and holes for mounting AIFX**

To mount the detached network interface Ethernet, the required panel cut-outs for the communication status LEDs and the Ethernet sockets as well as the holes for mounting the AIFX must be provided on the housing of the PC or connection device.

Panel cut-outs	The layout for the panel cut-outs must be sufficiently dimensioned for: <ul style="list-style-type: none"> • Two Ethernet RJ45 sockets (for channel 0 and channel 1), see also data sheet MOD JACK - MJIM, section References. • The two LEDs COM0 and COM1
Drill holes	2, at a distance of 37.0 mm
Further information	The dimensions for the required panel cut-outs or the distance between the holes can be taken from the dimension drawing of the AIFX, see section <i>Dimensions AIFX-V2-RE</i> [▶ page 52].

Table 10: Panel cut-outs and holes for AIFX mounting

- **Front panel width**

When dimensioning the front panel, note the width of the front panel specified in section *AIFX-V2-RE* [▶ page 43].

4.2 Requirements for operation

The following described requirements must be fulfilled when operating the PC card.

Requirements	Specification	See section
Hardware installation	Operating the PC card CIFX HPCI90-RE\F requires proper connection of the detached network interface Etherent AIFX-V2-RE to the basic card.	-
Communication	<p>For communication of a PC card (slave), a Master device is required for the communication system used.</p> <p>To configure the master device, you need a device description file for the slave used with the name for:</p> <ul style="list-style-type: none"> • EtherCAT-Slave: Hilscher CIFX RE NETX90 ECS.xml • EtherNet/IP-Adapter: HILSCHER CIFX-RE NETX90 EIS V1.1.EDS • POWERLINK Controlled Node: 00000044_NETX_90_RE_PLS.xdd • PROFINET IO-Device: GSDML-V2.35-HILSCHER-CIFX NETX 90 RE PNS-20200402.xml <p>The settings in the used master must match the settings in the slave.</p>	-
Software installation	<p>cifX Device Driver as the driver for the host interface (latest version of the driver).</p> <p>Device Explorer as software for downloading or updating the firmware and configuration, as well as for setting the device driver.</p> <p>Communication Studio for configuring and diagnosing netX 90-based devices.</p>	<i>Revision or version status of hardware and software [▶ page 8] and References [▶ page 53] (Driver and software documentation)</i>
Firmware download	<p>The user must select the firmware using the Device Explorer software and download it to the PC card.</p> <p>The firmware contains a communication protocol.</p>	
Parameter settings	<p>The PC card must be parameterized using the Communication Studio configuration software.</p>	

Table 11: Requirements for operation

4.3 Overview installation and firmware download

Below you find an overview of the steps to install the hardware, driver and firmware for your PC card CIFX HPCI90-REV:

Step	Description	See section
Downloading installation files	<ul style="list-style-type: none"> Download the installation files from the Hilscher website for: <ul style="list-style-type: none"> - cifX Device Driver (atest version) - Device Explorer - Communication Studio Save the installation files to the local hard disk of your PC. 	<i>Revision or version status of hardware and software</i> [▶ page 8]
Install drivers and software	<ul style="list-style-type: none"> Double-click the appropriate installation file to open the startup menu. Start the installation from the home screen and follow the instructions in the installation menu. 	
Install hardware	<ul style="list-style-type: none"> Take the protective measures and safety precautions for the hardware installation. Plug the cable into the cable connector on the basic card. Pay attention to the polarity. Open the housing of the PC or connection device. Insert the basic card into the Mini PCI Express slot and mount the basic card. Mount the detached network interface to the front panel of the PC. Connect the detached network interface to the basic card. Close the housing of the PC or connection device. 	<i>Installing the hardware</i> [▶ page 20]
Firmware and configuration download	<ul style="list-style-type: none"> Download the firmware according to the information in the "Device Explorer" user manual. <p>The PC card cifX is now ready for operation and has yet to be configured.</p> <ul style="list-style-type: none"> Then download the configuration. 	<i>Loading firmware and configuration in the device or making an update</i> [▶ page 21]

Table 12: Overview for installation and firmware download



For detailed descriptions of how to install and operate the software, refer to the relevant operating instruction manual, section *References* [▶ page 53].

4.4 Installation warnings

When installing your device, observe the following warnings on possible personal injury, as well as the warnings on property damage.

WARNING!



Hazardous voltage! Danger to life, risk of injury by electric shock

Hazardous voltages are present in the PC (or connection device).



- First disconnect the power plug of the PC (or connection device), before you open the housing.
- Make sure that the power supply is off at the PC (or connection device).

CAUTION

Personal injury, device damage due to hot swap/hot plug



The PC card is not designed or intended for a hot-swap or hot-plug connection.

Performing hot-swap or hot-plug may pose a hazard to the PC card, the system platform and the person performing the action.

NOTICE

Electrostatically sensitive devices



To prevent damage to the PC and PC card, make sure the PC card is grounded through the connection plate and PC, and make sure you are grounded when you install or uninstall the PC card.

NOTICE

Fracture of the basic card due to mechanical pressure



Do not exert any unnecessary force to the basic card, to prevent the circuit board from breaking.

During *installation* always adhere to the step sequence:

1. First plug the cable into the cable connector on the basic card.
2. Then insert the basic card into the Mini PCI Express slot and fasten it.

During *uninstallation* always adhere to the step sequence:

1. First unscrew the basic card and remove it from the Mini PCI Express slot.
2. Then pull the cable out of the cable connector on the basic card.

Installation warnings (USA)

When installing your device, observe the following warnings on possible personal injury, as well as the warnings on property damage.

WARNING



Hazardous voltage!
Danger to life, risk of injury by electric shock

Hazardous voltages are present in the PC (or connection device).



- First disconnect the power plug of the PC (or connection device), before you open the housing.
- Make sure that the power supply is off at the PC (or connection device).

CAUTION

Personal injury, device damage due to hot swap/hot plug

The PC card is not designed or intended for a hot-swap or hot-plug connection.

Performing hot-swap or hot-plug may pose a hazard to the PC card, the system platform and the person performing the action.

NOTICE

Electrostatically sensitive devices



To prevent damage to the PC and PC card, make sure the PC card is grounded through the connection plate and PC, and make sure you are grounded when you install or uninstall the PC card.

NOTICE



Fracture of the basic card due to mechanical pressure

Do not exert any unnecessary force to the basic card, to prevent the circuit board from breaking.

Adhere to the step sequence during *installation*:

1. First plug the cable into the cable connector on the basic card.
2. Then insert the basic card into the Mini PCI Express slot and fasten it.

Adhere to the step sequence during *uninstallation*:

1. First unscrew the basic card and remove it from the Mini PCI Express slot.
2. Then pull the cable out of the cable connector on the basic card.

4.5 Installing the hardware

Install the PC card CIFX HPCI90-RE\F in your PC or connection device as described below.

1. Preparation

Note the requirements and prerequisites described in the sections *System Requirements* [▶ page 14] and *Requirements for operation* [▶ page 16].



Important:

Note that the detached network interface Ethernet AIFX-V2-RE especially is designed for netX 90-based devices and exclusively works together with them.

In contrast, the detached network interface Ethernet AIFX-RE is only suitable for netX 100-based devices.

2. General protective measures and safety precautions

CAUTION Personal injury, device damage due to hot-plug/hot-swap

- Do not "plug" or "unplug" the PC card during operation.

NOTICE Electrostatic sensitive components

- Make sure that the device is grounded via the endplate and the PC, and make sure that you are discharged when you install/uninstall the device.

3. Connect cable

NOTICE Fracture of the basic card due to mechanical pressure

- Do not exert any unnecessary force to the basic card, to prevent the circuit board from breaking.
During *installation* always adhere to the step sequence:
 1. First plug the cable into the cable connector on the basic card.
 2. Then insert the basic card into the Mini PCI Express slot and fasten it.
- First, plug the cable into the cable connector Ethernet X801 on the basic card.



Figure 4: Plug the cable into the cable connector Ethernet on the basic card, example CIFX HPCI90

4. Installation

WARNING Hazardous voltage! Danger to life, risk of injury by electric shock

- Disconnect the power plug of the PC (or connection device).
- Make sure that the power supply is off at the PC (or connection device).
- Open the housing of the PC or connection device.

NOTICE Fracture of the basic card due to mechanical pressure

- Do not exert any unnecessary force to the basic card, to prevent the circuit board from breaking.
- Insert the basic card into the Mini PCI Express slot.

NOTICE Over torquing of the mounting screws

- Do not over torque the screws used to mount the basic card to the board, to prevent damage to the printed circuit board.
- Screw the basic card onto the board. To do this, use the two holes in the upper part of the basic card.
- Attach the detached network interface Ethernet AIFX-V2-RE to the housing panel of the PC or connection device.
- Connect the detached network interface Ethernet AIFX-V2-RE to the basic card by plugging the cable (already connected to the basic card) into the cable connector fieldbus X1 on the AIFX-V2-RE.

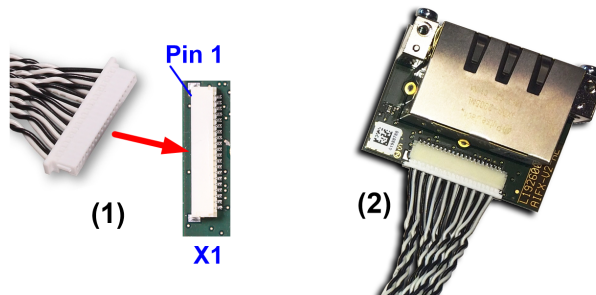

Figure 5: Plug the cable into the cable connector fieldbus X1 on the AIFX-V2-RE

- Close the housing of the PC or connection device again.

4.6 Loading firmware and configuration in the device or making an update

- Download the firmware from the Hilscher website and save the firmware on the local hard disk of your PC.
- If necessary, transfer the configuration to the PC. You create the configuration using a suitable configuration software.
- Use **Device Explorer** to load the firmware and configuration into the device or update the firmware and configuration in your device.
- When downloading the firmware and configuration to your device or when performing an update, follow the instructions in the "Device Explorer" operating instruction manual.



For the "Device Explorer" operating instruction manual, see section *References* [▶ page 53].

4.7 Hints for problem solving

In case of an error or malfunction during operation of your PC card cifX, observe the following troubleshooting instructions:

General

- Check that the requirements for operation of the PC card are met according to the information provided in this user manual.

SYS and COM status LEDs

You can troubleshoot the system by checking the behavior of the LEDs.

- The SYS LED (yellow/green) on the device indicates the general device status and can be switched on, off or blinks.
- The LEDs COM0 (red/green) and COM1 (red/green) at the detached network interface Ethernet indicate the status of the device communication and may be switched on or off permanently or in phases, flash or they blink cyclically or acyclically.

If the SYS LED lights static green and the COM0 LED lights static green or "off" (or the COM LEDs behave as shown in the table below), the PC card cifX is in the "in operation" state. The slave device is in the state of cyclic communication with the connected master device. The communication between the master device and the slave device runs without interference.

Cable

- Check that the pin assignment of the cable used to connect the PC card (Slave) to the Master device is correct.



Detailed descriptions of the behavior of the LEDs can be found in the chapter on LEDs in this manual. Information about the device diagnostics and its functions can be found in the user manual of the configuration software for your device.

4.8 Uninstalling the hardware

Uninstall the PC card CIFX HPCIE90-RE\F from the PC or connection device as described below.

1. Protective measures and safety precautions

CAUTION Personal injury, device damage due to hot-plug/hot-swap

- Do not "plug" or "unplug" the PC card during operation.

NOTICE Electrostatic sensitive components

- Make sure that the device is grounded via the endplate and the PC, and make sure that you are discharged when you install/uninstall the device.

2. Uninstallation

WARNING Hazardous voltage! Danger to life, risk of injury by electric shock

- Disconnect the power plug of the PC (or connection device).
- Make sure that the power supply is off at the PC (or connection device).
- Open the housing of the PC or connection device.

NOTICE Fracture of the basic card due to mechanical pressure

- Do not exert any unnecessary force to the basic card, to prevent the circuit board from breaking.
During *uninstallation* always adhere to the step sequence:
 1. First unscrew the basic card and remove it from the Mini PCI Express slot.
 2. Then pull the cable out of the cable connector on the basic card.
- Loosen the screw that secures the basic card to the board.
- Remove the basic card from the Mini PCI Express slot.
- Remove the detached network interface from the housing cover of the PC or connection device.
- Close the housing of the PC or connection device again.
- Demount the detached network interface Ethernet from the basic card.
- Therefore pull the cable out of the cable connector Ethernet X801 (on the basic card), as well as out of the cable connector Ethernet X1 on the AIFX-V2-RE.

4.9 Disposal and recycling of waste electronic equipment

Waste electronic equipment must be disposed of properly after the end of use.



Waste electronic equipment

This product must not be disposed of with household waste.

Dispose of this product in accordance with local regulations in your country.

When disposing of the product, observe the following:

- Observe national and local regulations for the disposal of waste electronic equipment and packaging.
- Delete personal data stored in the waste electronic device.
- Dispose of this product in an environmentally friendly manner at a local collection point for waste electronic equipment.
- Dispose of packaging in such a way that a high level of recycling is possible.

Alternatively, you can return our products to us for disposal. The prerequisite is that no additional foreign substances are contained. Before returning, please contact us via the Return Merchandise Authorization (RMA) form on www.hilscher.com.

In Europe, the directive 2012/19/EU waste electrical and electronic equipment applies. Different policies and laws may apply nationally.

5 Diagnosis with LEDs

5.1 Overview



Note:

The communication status and Ethernet LEDs on the device are determined by the loaded protocol firmware.

LED		EtherCAT Slave	EtherNet/IP	Open Modbus/ TCP	POWERLINK Controlled Node	PROFINET IO
SYS System status ● Yellow ● Green Yellow/green		SYS	SYS	SYS	SYS	SYS
COM 0 Communication status		RUN ● Green	MS ● Red ● Green Red/green	RUN ● Green	BS ● Green	SF ● Red
COM 1 Communication status		ERR ● Red	NS ● Red ● Green Red/green	ERR ● Red	BE ● Red	BF ● Red
Ethernet Ch0	Green	L/A IN	LINK	LINK	L/A	LINK
	● Yellow	-	ACT	ACT	-	RX/TX
Ethernet Ch1	Green	L/A OUT	LINK	LINK	L/A	LINK
	● Yellow	-	ACT	ACT	-	RX/TX

Table 13: LEDs Real-Time Ethernet systems (duo LEDs and Ethernet LEDs)

Category	LED	Name	Category	LED	Name
System status	SYS	System status	Ethernet	LINK, L	Link
Communication status	COM	Communication status		ACT, A	Activity
	RUN	Run		L/A	Link/Activity
	ERR	Error		L/A IN	Link/Activity Input
	MS	Module status		L/A OUT	Link/Activity Output
	NS	Network status		RX/TX	Receive/Transmit
	BS	Bus status			
	BE	Bus error			
	SF	System error			
BF	Bus failure				

Table 14: LED designations

5.2 System LED

The system status LED **SYS** can assume the states described below.







LED	Color	State	Description
SYS	Duo-LED: yellow RDY / green RUN		
	 (green)	On	The firmware is running.
	 (green)	Blinking	During the formatting of the file system
	 (yellow)	On	A system error has occurred.
	 (yellow)/ (green)	Blinking, 3x yellow, 3x green	Firmware crash, unrecoverable (an internal exception occurred that cannot be handled)
	 (yellow)/ (green)	Blinking, 1 Hz	Firmware update mode active: The firmware is idle and waiting for the update file.
	 (yellow)/ (green)	Blinking, 4 Hz	Firmware update mode active: A firmware update is being installed.
 (gray)	Off	<ul style="list-style-type: none"> No supply voltage: No supply voltage for the device or hardware defect. During a firmware reset 	

Table 15: States of the SYS-LED

LED state	Definition
Blinking	The LED turns on and off in phases.
Blinking, 3x yellow, 3x green	The LED turns on and off, with a frequency of approx. 1 Hz: <ul style="list-style-type: none"> 3x yellow "On" for 500 ms and "Off" for 500 ms and 3x green "On" for 500 ms and "Off" for 500 ms.
Blinking, yellow/green, 1 Hz, 4 Hz	The LED turns on in phases yellow or green, with a frequency of approx.: <ul style="list-style-type: none"> 1 Hz: 1 x yellow "On" for 500 ms and 1 x green "On" for 500 ms, 4 Hz: 1 x yellow "On" for 125 ms and 1 x green "On" for 125 ms.

Table 16: Definitions of the states of the SYS LED

5.3 EtherCAT Slave

For the EtherCAT Slave protocol, the communication LEDs **RUN** and **ERR** as well as the Ethernet LED **L/A IN** or **L/A OUT** can assume the states described below. This description is valid from stack version V2.5 (V2).

Communication status EtherCAT Slave

LED	Color	State	Description
RUN Position in the device overview: (10)	Duo LED red/green		
	● (off)	Off	INIT: The device is in INIT state.
	☀ (green)	Blinking (2.5 Hz)	PRE-OPERATIONAL: The device is in PRE-OPERATIONAL state.
	☀ (green)	Single flash	SAFE-OPERATIONAL: The device is in SAFE-OPERATIONAL state.
	● (green)	On	OPERATIONAL: The device is in the OPERATIONAL state.
ERR Position in the device overview: (7)	Duo LED red/green		
	● (off)	Off	No error: The EtherCAT communication of the device is in working condition.
	☀ (red)	Blinking (2.5 Hz)	Invalid configuration: General Configuration Error Possible reason: State change commanded by master is impossible due to register or object settings.
	☀ (red)	Single flash	Local error: Slave device application has changed the EtherCAT state autonomously. Possible reason 1: A host watchdog timeout has occurred. Possible reason 2: Synchronization Error, device enters Safe-Operational automatically.
	☀ (red)	Double flash	Application watchdog timeout: An application watchdog timeout has occurred. Possible reason: Sync Manager Watchdog timeout.

Table 17: Communication status EtherCAT Slave

LED state	Definition
Blinking (2.5 Hz)	The LED turns on and off with a frequency of 2.5 Hz: "On" for 200 ms, followed by "Off" for 200 ms.
Single flash	The LED shows one short flash (200 ms) followed by a long "Off" phase (1,000 ms).
Double flash	The LED shows a sequence of two short flashes (each 200 ms), separated by a short "Off" phase (200 ms). The sequence is finished by a long "Off" phase (1,000 ms).

Table 18: Definition LED states communication status

Ethernet status EtherCAT Slave





LED	Color	State	Description
L/A IN, L/A OUT Ch0: (11) , Ch1: (8)	LED green		
	 (green)	On	Link: The device is linked to the Ethernet, but does not send/receive Ethernet frames.
	 (green)	Flickering (load dependent)	Activity: The device is linked to the Ethernet and sends/receives Ethernet frames.
	 (off)	Off	The device has no link to the Ethernet.
Ch0: (9) , Ch1: (6)	LED yellow		
	 (off)	Off	This LED is not used.

Table 19: Ethernet status EtherCAT Slave

LED state	Definition
Flickering (load dependent)	The LED turns on and off with a frequency of approximately 10 Hz to indicate high Ethernet activity: "On" for approximately 50 ms, followed by "Off" for 50 ms. The LED turns on and off in irregular intervals to indicate low Ethernet activity.

Table 20: Definition LED states Ethernet status

5.4 EtherNet/IP Adapter (V3/5)

For the EtherNet/IP Adapter protocol, the communication LEDs **MS** and **NS** as well as the Ethernet LEDs **LINK** and **ACT** can assume the states described below. This description is valid from stack version V3.4 or from V5.1.

Communication status EtherNet/IP Adapter















LED	Color	State	Description
MS (module status) Position in the device overview: (10)	Duo LED red/green		
	 (green)	On	Device operational: The device is operating correctly.
	 (green)	Flashing (1 Hz)	Standby: The device has not been configured.
	 (green/red/green)	Flashing fast green/red/green	Self-test: The device performs a self-test after power-on. The following sequence is displayed during the self-test: <ul style="list-style-type: none"> • NS-LED off. • MS LED turns green for approximately 250 ms, turns red for approximately 250 ms, and again turns green (and holds that state until the power-up test has completed). • NS LED turns green for approximately 250 ms, turns red for approximately 250 ms, and then turns off (and holds that state until the power-up test has completed).
	 (red/green/off)	Flashing sequence red/green/off	Flashing sequence: The flashing sequence is used to visually identify the device. The scanner can start the flashing sequence in Identity object 1 of the device. The MS LED and NS LED perform the flashing sequence simultaneously.
	 (red)	Flashing (1 Hz)	Major recoverable fault: The device has detected a major recoverable fault. E.g., an incorrect or inconsistent configuration can be considered a major recoverable fault.
	 (red)	On	Major unrecoverable fault: The device has detected a major unrecoverable fault.
 (off)	Off	No power: The device is powered off.	
NS (Network status) Position in the device overview: (7)	Duo LED red/green		
	 (green)	On	Connected: An IP address is configured, at least one CIP connection (any transport class) is established, and an Exclusive Owner connection has not timed out.
	 (green)	Flashing (1 Hz)	No connections: An IP address is configured, but no CIP connections are established, and an Exclusive Owner connection has not timed out.
	 (green/red/green)	Flashing fast green/red/green	Self-test: The device performs a self-test after power-on. Refer to the description of the MS LED in the self-test status.
	 (red/green/off)	Flashing sequence red/green/off	Flashing sequence: The flashing sequence is used to visually identify the device. The scanner can start the flashing sequence in Identity object 1 of the device. The MS LED and NS LED perform the flashing sequence simultaneously.
	 (red)	Flashing (1 Hz)	Connection timeout: An IP address is configured, and an Exclusive Owner connection for which this device is the target has timed out. The NS LED returns to steady green only when all timed out Exclusive Owner connections are reestablished.
	 (red)	On	Duplicate IP: The device has detected that its IP address is already in use.
 (off)	Off	Not powered, no IP address: The device does not have an IP address (or is powered off).	

Table 21: Communication status EtherNet/IP Adapter

LED state	Definition
Flashing (1 Hz)	The LED turns on and off with a frequency of 1 Hz: "On" for 500 ms, followed by "Off" for 500 ms.
Flashing fast green/red/green	The MS LED or NS LED turns on green "On" for 250 ms, then red "On" for 250 ms, then green "On" (until the test is completed).
Flashing sequence red/green/off	The MS LED and NS LED each turn red "On" for 500 ms, then green "On" for 500 ms, then "Off" for 500 ms. This flashing sequence is repeated at least 6 times.

Table 22: Definition LED states communication status

Ethernet status EtherNet/IP Adapter





LED	Color	State	Description
LINK Ch0: (11) , Ch1: (8)	LED green		
	 (green)	On	The device is linked to the Ethernet.
	 (off)	Off	The device has no link to the Ethernet.
ACT Ch0: (9) , Ch1: (6)	LED yellow		
	 (yellow)	Flickering (load dependent)	The device sends/receives Ethernet frames.
	 (off)	Off	The device does not send/receive Ethernet frames.

Table 23: Ethernet status EtherNet/IP Adapter

LED state	Definition
Flickering (load dependent)	The LED turns on and off with a frequency of approximately 10 Hz to indicate high Ethernet activity: "On" for approximately 50 ms, followed by "Off" for 50 ms. The LED turns on and off in irregular intervals to indicate low Ethernet activity

Table 24: Definition LED states Ethernet status

5.5 OpenModbusTCP

For the OpenModbusTCP protocol, the communication LEDs **RUN** and **ERR** as well as the Ethernet LEDs **LINK** and **ACT** can assume the states described below. This description is valid from stack version V0.9.

Communication status OpenModbusTCP







LED	Color	State	Description
RUN Position in the device overview: (10)	Duo LED red/green		
	 (green)	On	Connected: OMB task has communication. At least one TCP connection is established.
	 (green)	Flashing (1 Hz)	Ready, not configured yet: OMB task is ready and not yet configured.
	 (green)	Flashing (5 Hz)	Waiting for Communication: OMB task is configured.
	 (off)	Off	Not Ready: OMB task is not ready.
ERR Position in the device overview: (7)	Duo LED red/green		
	 (off)	Off	No communication error
	 (red)	Flashing (2 Hz, 25% on)	System error
	 (red)	On	Communication error active

Table 25: Communication status OpenModbusTCP

LED state	Definition
Flashing (1 Hz)	The LED turns on and off with a frequency of 1 Hz: "On" for 500 ms, followed by "Off" for 500 ms.
Flashing (5 Hz)	The LED turns on and off with a frequency of 5 Hz: "On" for 100 ms, followed by "Off" for 100 ms.
Flashing (2 Hz, 25% on)	The LED turns on and off with a frequency of 2 Hz: "On" for 125 ms, followed by "Off" for 375 ms.

Table 26: Definition LED states communication status

Ethernet status OpenModbusTCP





LED	Color	State	Description
LINK Ch0: (11) , Ch1: (8)	LED green		
	 (green)	On	The device is linked to the Ethernet.
	 (off)	Off	The device has no link to the Ethernet.
ACT Ch0: (9) , Ch1: (6)	LED yellow		
	 (yellow)	Flickering (load dependent)	The device sends/receives Ethernet frames.
	 (off)	Off	The device does not send/receive Ethernet frames.

Table 27: Ethernet status OpenModbusTCP

LED state	Definition
Flickering (load dependent)	The LED turns on and off with a frequency of approximately 10 Hz to indicate high Ethernet activity: "On" for approximately 50 ms, followed by "Off" for 50 ms. The LED turns on and off in irregular intervals to indicate low Ethernet activity.

Table 28: Definition LED states Ethernet status

5.6 POWERLINK Controlled Node

For the POWERLINK Controlled Node protocol, the communication LEDs **BS** (Busstatus) and **BE** (Bus-Error) as well as the Ethernet LED L/A can assume the states described below. This description is valid from stack version V3.0.

Communication status POWERLINK Controlled Node









LED	Color	State	Description
BS (Bus status)	Duo LED red/green		
	 (green)	On	Slave is in state , Operational ' state.
	 (green)	Triple flash	Slave is in , ReadyToOperate ' state.
	 (green)	Double flash	Slave is in , Pre-Operational 2 ' state.
	 (green)	Single flash	Slave is in , Pre-Operational 1 ' state.
	 (green)	Flickering (10 Hz)	Slave is in , Basic Ethernet ' state.
	 (green)	Blinking (2.5 Hz)	Slave is in , Stopped ' state.
	 (off)	Off	Slave initializing
BE (Bus error)	Duo LED red/green		
	 (off)	Off	Slave has no error
	 (red)	On	Slave has detected an error

Table 29: Communication status POWERLINK Controlled Node

LED state	Definition
Triple flash	The LED shows a sequence of three short flashes (each 200 ms), separated by a short "Off" phase (200 ms). The sequence is finished by a long "Off" phase (1,000 ms).
Double flash	The LED shows a sequence of two short flashes (each 200 ms), separated by a short "Off" phase (200 ms). The sequence is finished by a long "Off" phase (1,000 ms).
Single flash	The LED shows one short flash (200 ms) followed by a long "Off" phase (1,000 ms).
Flickering (10 Hz)	The LED turns on and off with a frequency of 10 Hz: "On" for 50 ms, followed by "Off" for 50 ms. The red LED and the green LED are switched on alternately.
Blinking (2.5 Hz)	The LED turns on and off with a frequency of 2.5 Hz: "On" for 200 ms, followed by "Off" for 200 ms. The red LED and the green LED are switched on alternately.

Table 30: Definition of LED states communication status

Ethernet status POWERLINK Controlled Node





LED	Color	State	Description
L/A	LED green		
	 (green)	On	Link: The device is linked to the Ethernet, but does not send/ receive Ethernet frames.
	 (green)	Flickering (load dependent)	Activity: The device is linked to the Ethernet and sends/receives Ethernet frames.
	 (off)	Off	The device has no link to the Ethernet.
	LED yellow		
	 (off)	Off	This LED is not used.

Table 31: Ethernet status POWERLINK Controlled Node

LED state	Definition
Flickering (load dependent)	The LED turns on and off with a frequency of approximately 10 Hz to indicate high Ethernet activity: "On" for approximately 50 ms, followed by "Off" for 50 ms. The LED turns on and off in irregular intervals to indicate low Ethernet activity.

Table 32: Definition of LED state Ethernet status

5.7 PROFINET IO-Device

For the PROFINET IO-Device protocol, the communication LEDs **SF** (system failure) and **BF** (bus failure) as well as the Ethernet LEDs **LINK** and **RX/TX** can assume the states described below. This description is valid from stack version V3.x (V3).

Communication status PROFINET IO-Device

LED	Color	State	Description
SF (System Failure) Position in the device overview: (10)	Duo LED red/green		
	● (off)	Off	No error
	☀ (red)	Flashing (1 Hz, 3 s)	DCP signal service is initiated via the bus.
	● (red)	On	Watchdog timeout; channel, generic or extended diagnosis present; system error
BF (Bus Failure) Position in the device overview: (7)	Duo LED red/green		
	● (off)	Off	No error
	☀ (red)	Flashing (2 Hz)	No data exchange
	● (red)	On	No configuration; or low speed physical link; or no physical link

Table 33: Communication status PROFINET IO-Device

LED state	Definition
Flashing (1 Hz, 3 s)	The LED turns on and off for 3 seconds with a frequency of 1 Hz: "On" for 500 ms, followed by "Off" for 500 ms.
Flashing (2 Hz)	The LED turns on and off with a frequency of 2 Hz: "On" for 250 ms, followed by "Off" for 250 ms.

Table 34: Definition LED states communication status

Ethernet status PROFINET IO-Device

LED	Color	State	Description
LINK Ch0: (11) , Ch1: (8)	LED green		
	● (green)	On	The device is linked to the Ethernet.
	● (off)	Off	The device has no link to the Ethernet.
RX/TX Ch0: (9) , Ch1: (6)	LED yellow		
	☀ (yellow)	Flickering (load dependent)	The device sends/receives Ethernet frames.
	● (off)	Off	The device does not send/receive Ethernet frames.

Table 35: Ethernet status PROFINET IO-Device

LED state	Definition
Flickering (load dependent)	The LED turns on and off with a frequency of approximately 10 Hz to indicate high Ethernet activity: "On" for approximately 50 ms, followed by "Off" for 50 ms. The LED turns on and off in irregular intervals to indicate low Ethernet activity.

Table 36: Definition LED states Ethernet status

6 Connectors

6.1 Ethernet RJ45 socket

100BASE-TX and 10BASE-T



Note:

The device supports the Auto-Crossover function causing RX and TX to be exchanged where appropriate. The following figure shows the RJ45 standard pin assignment.

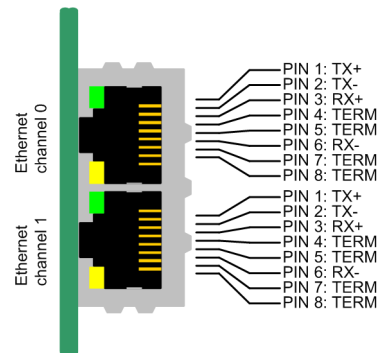

Figure 6: Ethernet pin assignment at the RJ45 socket

Pin	Signal	Meaning
1	TX+	Transmit data positive channel
2	TX-	Transmit data negative channel
3	RX+	Receive data positive channel
4	Term 1	Bridged and terminated to PE via RC link*
5	Term 1	
6	RX-	Received data negative channel
7	Term 2	Bridged and terminated to PE via RC link*
8	Term 2	
*Bob Smith Termination		

Table 37: Ethernet pin assignment at the RJ45 socket



Note:

The RJ45 connector may only be used for LAN, not for telecommunications connections.

6.2 Data of the Ethernet connection

For the Ethernet interface use RJ45 plugs and twisted pair cable of category 5 (CAT5) or higher, which consists of 4 twisted cores and has a maximum transfer rate of 100 MBit/s (CAT5).

	100BASE-TX and 10BASE-T
Medium	2 x 2 twisted pair copper cables, CAT5 (100 MBit/s)
Length of cable	Max. 100 m
Transfer rate	10 MBit/s/100 MBit/s

Table 38: Ethernet connection data 100BASE-TX and 10BASE-T

6.3 Usability of hubs and switches

The use of hubs or switches is prohibited or permitted for the respective communication systems. The following table shows the usability of hubs and switches per communication system:

Communication system	Hub	Switch
EtherCAT	Forbidden	Only permitted between EtherCAT Master and first EtherCAT Slave (100 MBit/s, full duplex)
EtherNet/IP	Allowed	Allowed (10 MBit/s/100 MBit/s, full or half duplex, auto-negotiation)
Open Modbus/TCP	Allowed	Allowed (10 MBit/s/100 MBit/s, full or half duplex, auto-negotiation)
POWERLINK	Allowed	Forbidden
PROFINET IO	Forbidden	Only allowed if the switch supports 'priority tagging' and LLDP (100 MBit/s, full duplex)

Table 39: Usability of hubs and switches

6.4 Cable connector Ethernet X801 on CIFX HPCIE90

Pin assignment for cable connector Ethernet X801 (BM20B-SRDS-G-T) on the basic card CIFX HPCIE90, cable 20-pin Ethernet and status LEDs

Pin	Name	Description	Type
1	GND	Ground	Power
2	3V3	3.3V Power	Power
3	-	(not used)	NC
4	MLED0 (COM0)	LED COM0 (red/green)	Output
5	I2C_SCL	I2C clock signal	Output
6	I2C_SDA	I2C data signal	Input / Output
7	-	(not used)	NC
8	MLED2 (LINK/ACT0)	LED LINK/ACT0 (yellow/green)	Output
9	RSTOUT#	Reset out	Output
10	MLED1 (COM1)	LED COM1 (red/green)	Output
11	CH0_TXP	Channel 0 TX+	Output
12	CH0_TXN	Channel 0 TX-	Output
13	CH0_RXP	Channel 0 RX+	Input
14	CH0_RXN	Channel 0 RX-	Input
15	CH1_TXP	Channel 1 TX+	Output
16	CH1_TXN	Channel 1 TX-	Output
17	CH1_RXP	Channel 1 RX+	Input
18	CH1_RXN	Channel 1 RX-	Input
19	-	(not used)	NC
20	MLED3 (LINK/ACT1)	LED LINK/ACT1 (yellow/green)	Output

Table 40: Pin assignment for cable connector Ethernet X801 (BM20B-SRDS-G-T) on CIFX HPCIE90

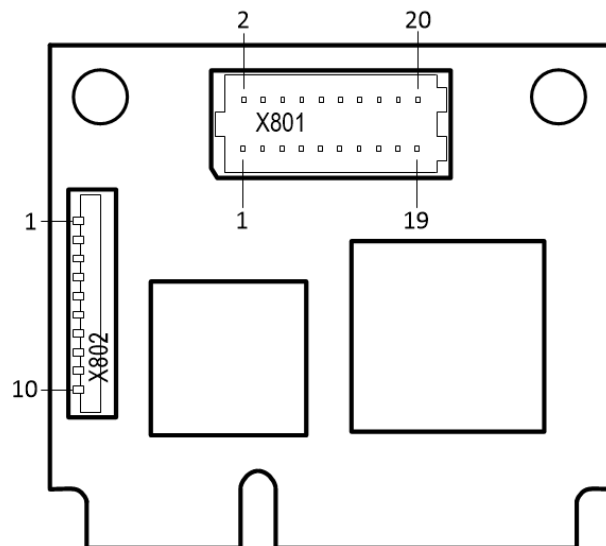

Figure 7: Connector fieldbus X801 (1x10 pins) on CIFX HPCIE90

6.5 Cable connector Ethernet X1 on AIFX-V2-RE

Pin assignment for cable connector Ethernet X1 on AIFX-V2-RE, cable 20-pin Ethernet and status LEDs

Pin	Name	Description	Type
1	GND	Ground	Power
2	3V3	3.3V Power	Power
3	-	(not used)	NC
4	MLED0 (COM0)	LED COM0 (red/green)	Input
5	-	(not used)	NC
6	-	(not used)	NC
7	-	(not used)	NC
8	MLED2 (LINK/ACT0)	LED LINK/ACT0 (yellow/green)	Input
9	RSTOUT#	Reset out	Input
10	MLED1 (COM1)	LED COM1 (red/green)	Input
11	CH0_TXP	Channel 0 TX+	Input
12	CH0_TXN	Channel 0 TX-	Input
13	CH0_RXP	Channel 0 RX+	Output
14	CH0_RXN	Channel 0 RX-	Output
15	CH1_TXP	Channel 1 TX+	Input
16	CH1_TXN	Channel 1 TX-	Input
17	CH1_RXP	Channel 1 RX+	Output
18	CH1_RXN	Channel 1 RX-	Output
19	-	(not used)	NC
20	MLED3 (LINK/ACT1)	LED LINK/ACT1 (yellow/green)	Input

Table 41: Pin assignment for cable connector Ethernet X1 on AIFX-V2-RE

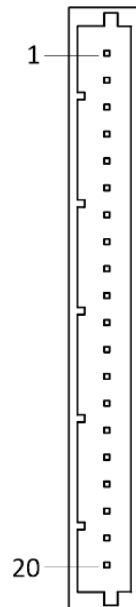

Figure 8: Cable connector Ethernet X1 (1x20 pins) on AIFX-V2-RE

6.6 Mini PCI Express Bus (H2)

The following table applies for pin assignment on the Mini PCI Express (H2) bus of the PC card CIFX HPCIE90 (basic card).

Pin	Name	Description	Type
1	PEWAKE#	PCIe WAKE#. Open Drain with pull up on Platform. Active Low when used as PEWAKE#. When the Adapter supports wakeup, this signal is used to request that the system return from a sleep/suspend state to service a function-initiated wake event. When the Adapter supports OBFF mechanism, the PEWAKE#signal is used for OBFF signaling.	I/O
2	3.3Vaux	3.3V auxiliary supply	Power
3	NC	(not used)	-
4	GND	Return current path.	Power
5	NC	(not used)	-
6	1.5V	1.5V supply	Power
7	CLKREQ#	PCIe Clock Request is a reference clock request signal as defined by the PCI Express Mini CEM Specification. This signal is also used by L1PM Substates. Open Drain with pull up on Platform. Active Low.	I/O
8	NC	(not used)	-
9	GND	Return current path.	Power
10	NC	(not used)	-
11	REFCLKN	PCIe Reference Clock signals (100 MHz) defined by the PCI Express CEM Specification.	Input
12	NC	(not used)	-
13	REFCLKP	PCIe Reference Clock signals (100 MHz) defined by the PCI Express CEM Specification.	Input
14	NC	(not used)	-
15	GND	Return current path.	Power
16	NC	(not used)	-
17	NC	(not used)	-
18	GND	Return current path.	Power
19	NC	(not used)	-
20	NC	(not used)	-
21	GND	Return current path.	Power
22	PERST#	PCIe Reset is a functional reset to the card as defined by the PCI Express Mini CEM Specification.	Input
23	PERn0	PCIe TX/RX Differential signals defined by the PCI Express CEM Specification.	Input
24	3.3Vaux	3.3V auxiliary supply	Power
25	PERp0	PCIe TX/RX Differential signals defined by the PCI Express CEM Specification.	Input
26	GND	Return current path.	Power
27	GND	Return current path.	Power
28	1.5V	1.5V supply	Power
29	GND	Return current path.	Power
30	NC	(not used)	-
31	PETn0	PCIe TX/RX Differential signals defined by the PCI Express CEM Specification.	Output
32	NC	(not used)	-
33	PETp0	PCIe TX/RX Differential signals defined by the PCI Express CEM Specification.	Output
34	GND	Return current path.	Power
35	GND	Return current path.	Power
36	NC	(not used)	-
37	GND	Return current path.	Power
38	NC	(not used)	-
39	3.3Vaux	3.3V auxiliary supply	Power

Pin	Name	Description	Type
40	GND	Return current path.	Power
41	3.3Vaux	3.3V auxiliary supply	Power
42	LED_WWAN	LED WWAN	Output
43	GND	Return current path.	Power
44	LED_WLAN	SYNC1: synchronisation pin for realtime systems	Output
45	NC	(not used)	-
46	LED_WPAN	SYNC0: synchronisation pin for realtime systems	Output
47	NC	(not used)	-
48	1.5V	1.5V supply	Power
49	NC	(not used)	-
50	GND	Return current path.	Power
51	NC	(not used)	-
52	3.3Vaux	3.3V auxiliary supply	Power

Table 42: Pin assignment Mini PCI Express (H2) bus X201, CIFX HPCIE90

7 Technical data

7.1 PC card CIFX HPCIE90-RE\F

Category	Parameter	Value	
Part		Name	Part number
	PC card (basic card with AIFX-V2-RE)	CIFX HPCIE90-RE\F	1424.101
	Basic card	CIFX HPCIE90	1424.100
	Function	Communication Interface Mini PCIe half-size , with Mini PCI Express interface and Ethernet interface. The use refers exclusively to slave systems.	
Communication controller	Type	netX 90	
Integrated memory	RAM	8 MB SDRAM	
	Flash	8 MB + 1 MB	
	Size of the Dual-Port Memory	64 Kbyte	
System interface	Bus type	Mini PCI Express (H2), one-lane port	
	Transmission rate	33 MHz	
	Data access	DPM	
	Dual-Port Memory (DPM) data access width	32-Bit	
Ethernet communication	Supported Real-Time Ethernet communication systems (determined by the loaded firmware)	EtherCAT Slave	
		EtherNet/IP Adapter	
		Open Modbus/TCP	
		POWERLINK Controlled Node	
	PROFINET IO-Device		
Ethernet frame types	Ethernet II		
Ethernet interface	Transmission rate	100 MBit/s, 10 MBit/s (depending on the firmware loaded)	
	Interface type	100BASE-TX, 10BASE-T (depending on firmware loaded)	
	Half duplex/full duplex	depending on the firmware loaded, supported (at 100 MBit/s)	
	Auto-negotiation	depending on the firmware loaded	
	Auto crossover	depending on the firmware loaded	
	Detached network interface Ethernet	AIFX-V2-RE Important! Operating the PC card CIFX HPCIE90-RE\F requires proper connection of the detached network interface Ethernet AIFX-V2-RE to the basic card.	
	Connector AIFX-V2-RE	Cable connector Ethernet X801 (JST BM20B-SRDS-G-TF, 1.0 mm pitch)	
Diagnosis with LEDs	LEDs	SYS	System status
Power supply	Supply voltage	+3.3 VDC -5% / +9%	
	Current consumption at 3.3 V	310 mA (maximum)	
	Connector	Via Mini PCI Express slot	

Category	Parameter	Value	
Environmental conditions	Operating temperature range*	-20 °C ... +70 °C	-20 °C ... +60 °C
	*Air flow, during measurement	0.5 m/s	0.0 m/s
	Storage temperature range	-40 °C ... +85 °C	
	Humidity	10% ... 95% relative humidity, no condensation permitted	
	Environment	The device must be used only in a pollution degree 2 environment (or better).	
Basic card CIFX HPCIE90	Dimensions (L x W x H)	26.8 x 30 x 7.5 mm	
	Component heights	The component height on the top of the basic card CIFX HPCIE90 exceeds the height of 1.5 mm specified by the standard, because the height of the cable connectors (Ethernet X801, or fieldbus X802), including the cable, is approximately 8.5 mm above the circuit board. The component height on the bottom of the basic card CIFX HPCIE90 complies with the standard specifications.	
	Weight	3.27 g	
	Mounting/installation	Mini PCI Express slot (3.3 V)	
EMC Compliance	CE sign	Yes	
	UKCA sign	Yes	
	Emission	DIN EN 61000-6-3/ BS EN 61000-6-3	
	Immunity	DIN EN 61000-6-2/ BS EN 61000-6-2	
	Documentation to prove the restriction of hazardous substances	EN 50581 / BS EN 50581	
	RoHS	Yes	
Firmware and configuration download	Software to download and update the firmware and configuration	Device Explorer	
Configuration	Configuration software	Communication Studio	

Table 43: Technical data CIFX HPCIE90-RE\F

7.2 PCI identifiers on the Mini PCI Express bus

The PC card CIFX HPCIE90-RE\F is a multifunction device on the Mini PCI Express (H2) bus and requires two PCI identifiers. The following identifiers apply:

PCI identifier	Value
Vendor ID	0x15CF
Device ID	0x0090
Subsystem vendor ID	0x15CF
Subsystem device ID	0x6001 (Flash-based device, SPM) 0x1002 (interrupt source, SPM)

Table 44: PCI identifiers on the Mini PCI Express bus

7.3 AIFX-V2-RE

Category	Parameter	Value	
Part	Name	AIFX-V2-RE	
	Part number	2801.100	
	Description	Detached network interface Ethernet for all netX 90-based devices. Important! The detached network interface PROFIBUS AIFX-V2-RE works exclusively together with netX 90 based devices.	
Interface PC card	Connector	Cable connector Ethernet X1 (JST SM20B-SRSS-TB(LF)(SN), 1.0 mm pitch)	
Ethernet interface	Galvanic isolation	isolated	
	Isolation voltage	1000 VDC (tested for 1 minute)	
	Connector	2 * RJ45 socket	
Diagnosis with LEDs	LEDs (on the reverse side of the device)	COM0	Communication status LED 0 (Duo LED)
		COM1	Communication status LED 1 (Duo LED)
		LED yellow	To RJ45Ch0 and RJ45Ch1, for Ethernet link status, Ethernet activity status, and other status
		LED green	
Power supply	Connector	Cable connector Ethernet X1	
Environmental conditions	Operating temperature range*	-20 °C ... +70 °C	-20 °C ... +60 °C
	*Air flow, during measurement	0.5 m/s	0.0 m/s
	Storage temperature range	-40 °C ... +85 °C	
	Humidity	10% ... 95% relative humidity, no condensation permitted	
	Environment	The device must be used only in a pollution degree 2 environment (or better).	
Device	Dimensions (L x W x H)	30.6 x 42.3 x 17.8 mm, front panel width = 18.5 mm	
	Mounting/installation	On the netX 90-based basic card: Cable connector Ethernet X801. Mounting to the housing of the PC or connection device.	
EMC Compliance	CE sign	Yes	
	UKCA sign	Yes	
	Emission, Immunity	Tested together with the corresponding basic card.	
	RoHS	Yes	

Table 45: Technical data AIFX-V2-RE

7.4 Communication protocols

7.4.1 EtherCAT Slave

Feature	Description
Maximum number of cyclic input data	1024 bytes
Maximum number of cyclic output data	1024 bytes
Acyclic communication (CoE)	SDO SDO Master-Slave SDO Slave-Slave (depending on master capability)
Type	Complex Slave
Supported protocols	SDO client and server side protocol CoE Emergency messages (CoE) Ethernet over EtherCAT (EoE) File Access over EtherCAT (FoE) Servo-over-EtherCAT (SoE)
Supported state machine	ESM (EtherCAT State Machine)
Supported of synchronization modes	Freerun: The application of the slave is not synchronized to EtherCAT Synchronous with SYNCMAN Event: The application of the slave is synchronized to the SM2/3 Event Synchronous with SYNC Event: The application of the slave is synchronized to the SYNC0 or SYNC1 Event
Supported features	PDI watchdog EtherCAT mailbox handling EtherCAT state machine handling Master-to-slave SDO communication Slave-to-slave SDO communication Integrated CoE object dictionary (ODV3) Ethernet over EtherCAT (EoE) handling File Access over EtherCAT (FoE) server
Number of FMMU channels	8
Number of Sync Manager channels	4
Distributed Clocks (DC)	Supported with 32-bit timestamps and isochronous PDI functionality (Sync0, Sync1)
Ethernet interface	Two Ethernet Interfaces 100BASE-TX Integrated Dual-PHY (supports Auto-Negotiation and Auto-Crossover)
Data transport layer	Ethernet II, IEEE 802.3

Feature	Description
Restrictions	EtherCAT Slave stack <ul style="list-style-type: none"> • AoE application interface not available ESC - EtherCAT Slave Controller <ul style="list-style-type: none"> • All DC related functions only 32 bit wide • No DC Latch functionality • No support of bit-wise FMMU mapping (Exception: Fill Status of Transmit Mailbox) • Restricted DC Sync signal generation <ul style="list-style-type: none"> – No Single-Shot Mode support – No Acknowledge Mode support • Restricted DC Control Functionality <ul style="list-style-type: none"> – No adjustment of Register Speed Counter Start (0x0930:0x931) – No showing of Register Speed Counter Diff (0x0932:0x933) • No MIO (PHY Management Interface) access from EtherCAT Master side • No physical Read-Write commands supported (APRW, FPRW, BRW)
Reference to stack version	V5.3

Table 46: Technical data EtherCAT Slave

7.4.2 EtherNet/IP Adapter

Parameter	Value
Maximum number of input data	504 bytes per assembly instance
Maximum number of output data	504 bytes per assembly instance
Maximum number of assembly instances	10
I/O connection types (implicit)	Exclusive Owner Listen Only Input Only
I/O connection trigger types	Cyclic (Minimum 1 ms*) Application triggered (Minimum 1 ms*) Change of State triggered (minimum 1 ms*) * depending on the number of connections and the input and output data
Explicit messages	Connected and unconnected
Unconnected Message Manager (UCMM)	Supported
Maximum number of connections	Implicit connections (Class 1): 5 Explicit connections (Class 3): 8 UCMM: 8

Parameter	Value
Predefined standard objects	Identity object (1, 0x01) Message Router object (2, 0x02) Assembly object (4, 0x04) Connection Manager (6, 0x06) Time Sync Object (67, 0x43) DLR object (71, 0x47) QoS object (72, 0x48) TCP/IP object (245, 0xF5) Ethernet Link object (246, 0xF6) LLDP Management Object (265, 0x109)
Maximum number of user-specific objects	20
Supported features	TCP/IP, UDP/IP DHCP, BOOTP Quick Connect Device level Ring (DLR) – Media redundancy Address Conflict Detection (ACD) Quality of Service CIP reset service: Identity object: Reset service type 0 and 1 QuickConnect LLDP, SNMP (LLDP MIB)
Ethernet interface	10 and 100 MBit/s Integrated switch
Duplex mode	Half-duplex, full-duplex, auto-negotiation
MDI mode	MDI, MDI-X, Auto-MDIX
Data transport layer	Ethernet II, IEEE 802.3
Restrictions	Tags are not supported. CIP Motion is not supported. CIP Safety is not supported. This means the protocol stack itself does not implement the safety application layer. This needs to be implemented on the host application side. However, the protocol stack supports all EtherNet/IP features that are necessary to build a CIP Safety capable device.
Reference to firmware/stack version	5.3

Table 47: Technical data EtherNet/IP Adapter

7.4.3 Open Modbus/TCP

Feature	Description
Maximum number of input data	5760 bytes (2880 registers)
Maximum number of output data	5760 bytes (2880 registers)
Acyclic communication	Read/write registers <ul style="list-style-type: none"> • Max. 125 registers per read telegram (FC 3, 4, 23) • Max. 121 registers per write telegram (FC 23) • Max. 123 registers per write telegram (FC 16) Read/write coils <ul style="list-style-type: none"> • Max. 2000 coils per read telegram (FC 1, 2) • Max. 1968 coils per write telegram (FC 15)
Modbus function codes	1, 2, 3, 4, 5, 6, 7, 15, 16, 23*, 43 * Function code 23 can be used via the packet API but not with the command table.
Protocol mode	Message mode (Client) <ul style="list-style-type: none"> • Client (using the command table in the configuration software: The data is stored in the I/O process data image) • Client and server (using the packet API: The I/O process data image is not used) E/A mode (Server) <ul style="list-style-type: none"> • (Only) Server (The data is stored in the I/O process data image)
Command table (Configuration API only)	Max. 16 server configurable Max. 256 commands
Baud rate	10 and 100 MBit/s
Data transport layer	Ethernet II, IEEE 802.3
Reference to firmware/stack version	V5.1

Table 48: Technical data Open Modbus/TCP

7.4.4 POWERLINK Controlled Node

Parameter	Description
Maximum number of cyclic input data	1490 bytes
Maximum number of cyclic output data	1490 bytes
Acyclic communication	SDO Upload/Download
Functions	SDO via ASND and UDP Slave to slave communication: Max. 8 slaves Cross-Traffic Multiplexing
Baud rate	100 MBit/s, half-duplex
Data transport layer	Ethernet II, IEEE 802.3
State Machine	State machine according to EPL specification
Ethernet POWERLINK version	V 2
Reference to firmware/stack version	V5.1

Table 49: POWERLINK Controlled Node

7.4.5 PROFINET IO-Device

Feature	Description
Maximum number of total cyclic input data	1440 bytes (including IOPS and IOCS)
Maximum number of total cyclic output data	1440 bytes (including IOPS and IOCS)
Maximum number of submodules	Depends on the firmware, can be configured via "Number of configurable submodules" in tag list. Up to 256 in general and may be smaller number for specific firmware. Note: If the application uses max. 2 APIs, the "Number of configurable submodules" can be used. Each further API reduces the total number of usable submodules by 1.
Multiple Application Relations (AR)	Depends on the firmware, can be configured via "Number of additional IO Connections (ARs)" in tag list. Up to 4 IO-ARs and one Supervisor-DA AR in general and may be smaller for numbers specific firmware.
Acyclic communication (Record objects)	Read/Write Record, max supported size can be configured via taglist.
Alarm types	Process Alarm, Diagnostic Alarm, Return Of Submodule Alarm, Plug Alarm (implicit), Pull Alarm (implicit), Update Alarm, Status Alarm, Upload and Retrieval Notification Alarm
Diagnosis entries	Depends on the firmware, can be configured via "Number of available Diagnosis buffers" in tag list. Up to 256 application diagnosis records of type Channel or Extended Channel Diagnosis in general and may be smaller number for specific firmware.
Identification & Maintenance (I&M)	I&M0 Read: Either built in for Slot 0 / Subslot 1 or pass through to application for any submodule. I&M1-5 Read/Write: Either built in for Slot 0 / Subslot 1 or pass through to application for any submodule. I&M4 and I&M5 are inactive by default.
Topology recognition	LLDP, SNMP V1, Physical Device Record Objects
Minimum cycle time (MinDeviceInterval)	netX90 Use case A firmware: RT_CLASS_3: 250 µs (min. SendClockFactor 8) netX90 Use case C firmware: RT_CLASS_3: 1 ms (min. SendClockFactor 32)
Media redundancy	MRP client
Additional supported features	„Shared Device“ „Fast Startup“ Asset Management PROFInergy ASE
Baud rate	100 MBit/s
Data transport layer	Ethernet II, IEEE 802.3
PROFINET IO specification	V2.4, PNIO_Version 2.41 legacy startup of specification V2.2 is supported
Conformance Class	C
Application IP stack API	The lwIP IP stack can be used by the application via Socket API Packets. The number of 8 sockets available to the Application can be configured via taglist.
Application Raw Ethernet API	Sending and Receiving Raw Ethernet Frames as Application is supported.

Feature	Description
Restrictions	<p>RT over UDP not supported.</p> <p>Multicast communication not supported.</p> <p>Only one device instance is supported.</p> <p>DHCP is not supported.</p> <p>The amount of configured IO-data influences the minimum cycle time that can be reached.</p> <p>Only 1 Input-CR and 1 Output-CR per AR are supported.</p> <p>The amount of usable submodules is reduced by 1 for each used different API (in case more than 2 APIs are used in parallel).</p> <p>Little endian byte order not supported.</p> <p>System Redundancy (SR-AR) and Dynamic Reconfiguration (formerly known as Configuration-in-Run, CiR) are not supported. (*)</p> <p>The usage of PROFINET CombinedObjectContainer</p> <ul style="list-style-type: none"> - is not supported at all (for standard firmware) - is not supported for user application parameters (for SystemRedundancy enabled firmware) (*) <p>SharedInput is not supported.</p> <p>MRPD is not supported.</p> <p>DFP and other HighPerformance-profile related features are not supported.</p> <p>Submodules cannot be configured or used by an AR in subslot 0.</p> <p>The stack does not support usage of PDEV submodules (InterfaceSubmodule or PortSubmodule) outside of slot 0. In addition the InterfaceSubmodule is only supported in subslot 0x8000 and the PortSubmodules are only supported in subslots 0x8001 and 0x8002.</p> <p>In case of using a firmware including the feature System Redundancy, the combination of the features "System Redundancy" and "Shared Device" is not supported. Recommendation: Set "NumberOfAdditional IO ARs" in tag list to 1.</p> <p>Applications implementing an application profile with a defined API != 0 (e.g. Profidrive, IO Link) need to handle I&M data on their own.</p> <p>(*) A separate PROFINET IO-Device firmware is available that support the features System Redundancy and Dynamic Reconfiguration. To use the firmware requires a separate license agreement.</p>
Reference to stack version	V5.4

Table 50: Technical data PROFINET IO-Device

The maximum values for number of submodules, Multiple Application Relations, Acyclic communication, and Diagnosis entries are configuration parameters in the tag list of a firmware. Each of these features require resources and have to be set in order to not exceed the available resource (e.g. RAM) of a device.

The same applies for the number of sockets to be used by application which is part of the tag list as well.

8 Dimensions

8.1 Tolerances of PCB dimensions

The manufacturing tolerance of the PCB dimensions shown is ± 0.1 mm per milled PCB edge. For all indicated dimensions of the printed circuit board, a tolerance of ± 0.1 mm (per milled edge) $\times 2 = \pm 0.2$ mm results for the length L and for the width B respectively.

$B = [\text{width dimension of printed circuit board in mm}] \pm 0.2 \text{ mm}$

$L = [\text{Length dimension of the PCB in mm}] \text{ mm} \pm 0.2 \text{ mm}$

The depth T of the PCB depends on the highest component used or the PCB thickness plus the descenders. The thickness of the PCB is = 1.0 mm ± 10 %.



Note:

The dimensions (L x W x H) given in the section *Technical data* [▶ page 41] (or the identical information in the product data sheet or on the Hilscher website) are rounded figures or the respective total measure (for example, including the front panel).

8.2 Dimensions CIFS HPCIE90

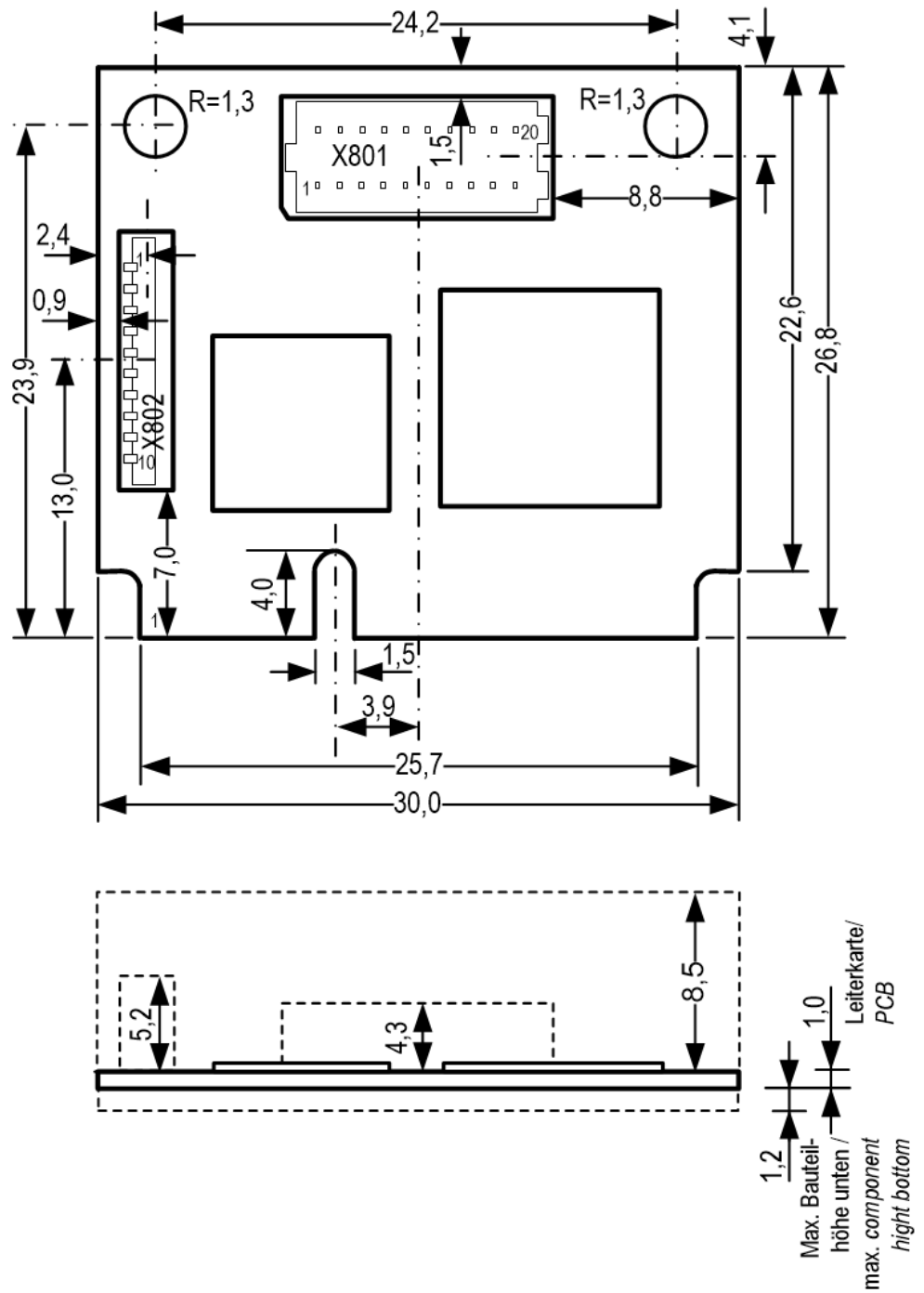

Figure 9: Dimensions CIFS HPCIE90 (Revision 4)



Note:

The height of the component on the top of the basic card HPCIE90 does not meet the standard specifications. For more information, see section *System Requirements* [▶ page 14].

8.3 Dimensions AIFX-V2-RE

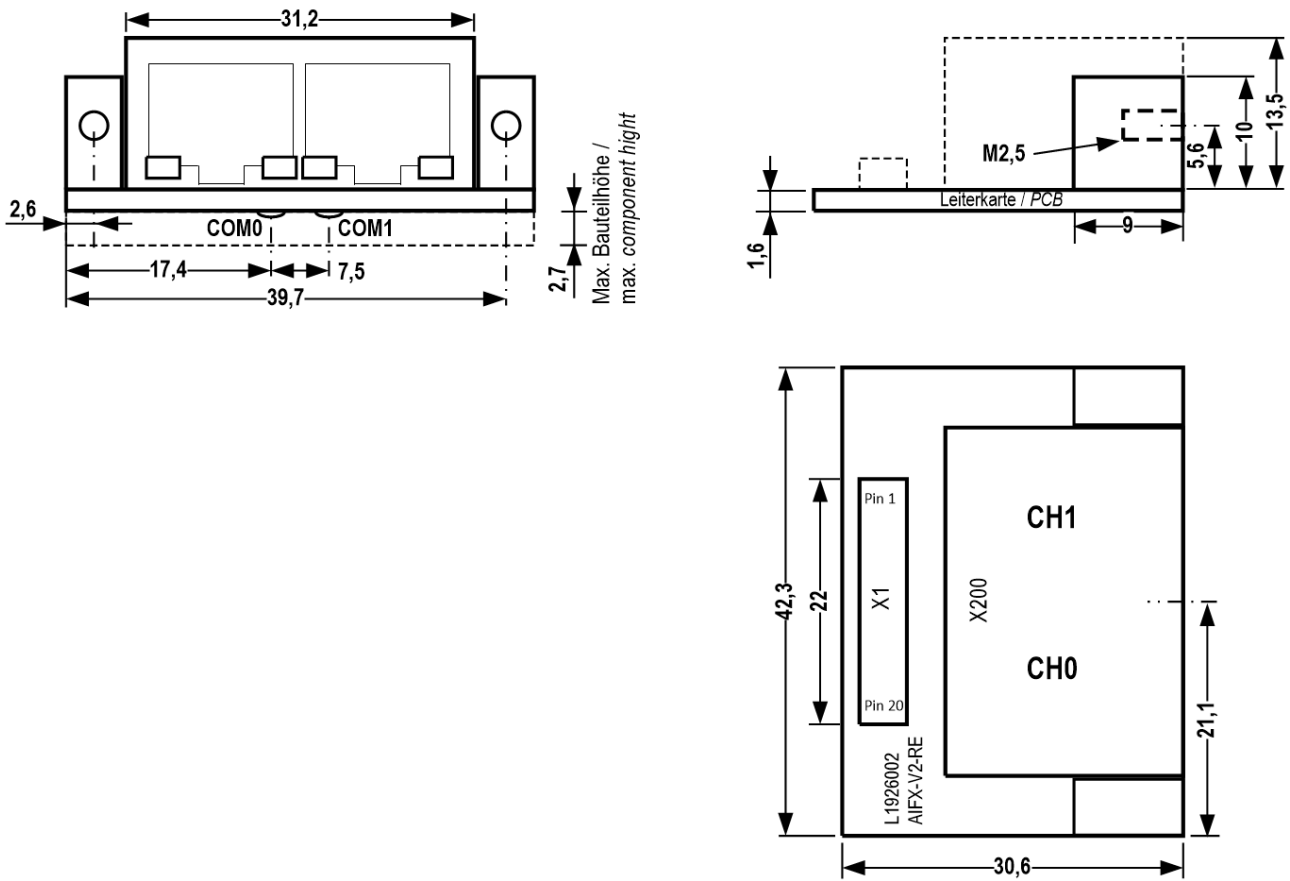

Figure 10: Dimensions AIFX-V2-RE (revision 2)

9 Appendix

9.1 FCC compliance

Federal Communications Commission (FCC)

This device complies with part 15 of the FCC Rules. Operation is subject to the following two conditions:

1. This device may not cause harmful interference, and
2. This device must accept any interference received, including interference that may cause undesired operation.

Note: This equipment has been tested and found to comply with the limits for a Class A digital device, pursuant to part 15 of the FCC Rules. These limits are designed to provide reasonable protection against harmful interference when the equipment is operated in a commercial environment. This equipment generates, uses, and can radiate radio frequency energy and, if not installed and used in accordance with the instruction manual, may cause harmful interference to radio communications. Operation of this equipment in a residential area is likely to cause harmful interference in which case the user will be required to correct the interference at his own expense.

9.2 References

PCI Express Mini Card Electromechanical Specification

PCI-SIG (Special interest Group), PCI Express Mini Card Electromechanical Specification, Revision 2.1, English, 2016-09

Protocol API Manuals

Hilscher Gesellschaft für Systemautomation mbH: Protocol API, EtherCAT Slave V5.3.0, Revision 4, DOC181005API04EN, English, 2021-09.

Hilscher Gesellschaft für Systemautomation mbH: Protocol API, EtherNet/IP Adapter V3.7.0 / V5.3.0, Revision 8, DOC150401API08EN Update 07, English, 2023-08

Hilscher Gesellschaft für Systemautomation mbH: Protocol API, Open Modbus/TCP V3.1.0 / V5.1.0, Revision 4, DOC180702API04EN, English, 2020-06.

Hilscher Gesellschaft für Systemautomation mbH: Protocol API, Ethernet POWERLINK Controlled Node V3.5.0 / V5.1.0, Revision 10, DOC160504API10EN, English, 2021-01.

Hilscher Gesellschaft für Systemautomation mbH: Protocol API, PROFINET IO-Device V5.4.0, Revision 4, DOC190103API04EN, English, 2019-12.

Documentation on drivers and software

Hilscher Gesellschaft für Systemautomation mbH: User manual, PC cards CIFS HPCIE90-RE\F Real-Time Ethernet, Hardware Description and Installation, DOC210802UMxxEN, English, 2021-xx.

Hilscher Gesellschaft für Systemautomation mbH: Operation instruction manual, cifX Device Driver, Installation and operation for Windows XP/ Vista/7/8/10, DOC060601OixxEN, English, 2019-01.

Hilscher Gesellschaft für Systemautomation mbH: Operating instruction manual, Device Explorer, Download firmware to the device, DOC190302OixxEN, English, 2021-02.

Hilscher Gesellschaft für Systemautomation mbH: Operating instruction manual, Communication Studio, Tool for Configuration and Diagnostics, DOC190501OixxEN, English, 2020-02.

Safety standards

American National Standards Institute, Inc.: American National Standard, Product Safety Information in Product Manuals, Instructions, and Other Collateral Materials, ANSI Z535.6-2016, English, 2016.

DIN Deutsches Institut für Normung e. v. and VDE Verband der Elektrotechnik Elektronik Informationstechnik e. V.: German standard, Equipment for audio/video, information and communication technology - Part 1: Safety requirements, (IEC 62368-1:2014, modified + Cor.:2015); English version EN 62368-1:2014 + AC:2015, English, 2016-05.

DIN Deutsches Institut für Normung e. v. and VDE Verband der Elektrotechnik Elektronik Informationstechnik e. V.: German standard, Electrostatics - Part 5-1: Protection of electronic components against electrostatic phenomena, General requirements, (IEC 61340-5-1:2016); English version EN 61340-5-1:2016, English, 2017-07.

DIN Deutsches Institut für Normung e. v. und VDE Verband der Elektrotechnik Elektronik Informationstechnik e. V.: German standard, Electrostatics - Part 5-2: Protection of electronic components against electrostatic phenomena, User manual, (IEC TR 61340-5-2:2018), DIN IEC/ TR 61340-5-2 (VDE V 0300-5-2), English, 2019-04.

Errata for ASIX Ax99100

Hilscher Gesellschaft für Systemautomation mbH: Errata, CIFS M223090AE, CIFS M224290BM and CIFS HPCIE90, Errata, DOC220201ERR03EN, English, 2022-03.

9.3 Conventions in this manual

Instructions for action and results

1. Operate purpose
2. Operate purpose
 - Instructions for action
 - Intermediate result
 - ⇒ Final result

Signs and signal words









Sign	Description	Sign	Description
	General note		Important note that must be followed to prevent malfunctions
	Reference on further information (acc. to ISO 7010 M001)		Disconnect the power plug (acc. to ISO 7010 M006)
	Warning of Personal Injury and Property Damage Message (acc. to ISO 7010 W001) USA: Warning of Personal Injury As in the scope of the ANSI Z535 Standard (for USA) instructions to a property damage message may not contain a warning triangle, this property damage messages are listed separately for the USA.		
	Warning of hazardous voltage! (acc. to ISO 7010 W012) Danger to life, risk of injury by electric shock		
	USA: Warning of hazardous voltage! (acc. to ANSI Z535.4) Danger to life, risk of injury by electric shock		
	Warning of damage due to electrostatic discharge (acc. to IEC 60417-5134)		

Table 51: Signs

Signal word	Description
DANGER	Indicates a hazardous situation, which if not avoided, will result in death or serious injury.
WARNING	Indicates a hazardous situation, which if not avoided, could result in death or serious injury.
CAUTION	Indicates a hazardous situation, which if not avoided, may result in minor or moderate Injury.
NOTICE	Indicates a property damage message.

Table 52: Signal words

9.4 Legal notes

Copyright

© Hilscher Gesellschaft für Systemautomation mbH

All rights reserved.

The images, photographs and texts in the accompanying materials (in the form of a user's manual, operator's manual, Statement of Work document and all other document types, support texts, documentation, etc.) are protected by German and international copyright and by international trade and protective provisions. Without the prior written consent, you do not have permission to duplicate them either in full or in part using technical or mechanical methods (print, photocopy or any other method), to edit them using electronic systems or to transfer them. You are not permitted to make changes to copyright notices, markings, trademarks or ownership declarations. Illustrations are provided without taking the patent situation into account. Any company names and product designations provided in this document may be brands or trademarks by the corresponding owner and may be protected under trademark, brand or patent law. Any form of further use shall require the express consent from the relevant owner of the rights.

Important notes

Utmost care was/is given in the preparation of the documentation at hand consisting of a user's manual, operating manual and any other document type and accompanying texts. However, errors cannot be ruled out. Therefore, we cannot assume any guarantee or legal responsibility for erroneous information or liability of any kind. You are hereby made aware that descriptions found in the user's manual, the accompanying texts and the documentation neither represent a guarantee nor any indication on proper use as stipulated in the agreement or a promised attribute. It cannot be ruled out that the user's manual, the accompanying texts and the documentation do not completely match the described attributes, standards or any other data for the delivered product. A warranty or guarantee with respect to the correctness or accuracy of the information is not assumed.

We reserve the right to modify our products and the specifications for such as well as the corresponding documentation in the form of a user's manual, operating manual and/or any other document types and accompanying texts at any time and without notice without being required to notify of said modification. Changes shall be taken into account in future manuals and do not represent an obligation of any kind, in particular there shall be no right to have delivered documents revised. The manual delivered with the product shall apply.

Under no circumstances shall Hilscher Gesellschaft für Systemautomation mbH be liable for direct, indirect, ancillary or subsequent damage, or for any loss of income, which may arise after use of the information contained herein.

Liability disclaimer

The hardware and/or software was created and tested by Hilscher Gesellschaft für Systemautomation mbH with utmost care and is made available as is. No warranty can be assumed for the performance or flawlessness of the hardware and/or software under all application conditions and scenarios and the work results achieved by the user when using the hardware and/or software. Liability for any damage that may have occurred as a result of using the hardware and/or software or the corresponding documents shall be limited to an event involving willful intent or a grossly negligent violation of a fundamental contractual obligation. However, the right to assert damages due to a violation of a fundamental contractual obligation shall be limited to contract-typical foreseeable damage.

It is hereby expressly agreed upon in particular that any use or utilization of the hardware and/or software in connection with

- Flight control systems in aviation and aerospace;
- Nuclear fission processes in nuclear power plants;
- Medical devices used for life support and
- Vehicle control systems used in passenger transport

shall be excluded. Use of the hardware and/or software in any of the following areas is strictly prohibited:

- For military purposes or in weaponry;
- For designing, engineering, maintaining or operating nuclear systems;
- In flight safety systems, aviation and flight telecommunications systems;
- In life-support systems;
- In systems in which any malfunction in the hardware and/or software may result in physical injuries or fatalities.

You are hereby made aware that the hardware and/or software was not created for use in hazardous environments, which require fail-safe control mechanisms. Use of the hardware and/or software in this kind of environment shall be at your own risk; any liability for damage or loss due to impermissible use shall be excluded.

Warranty

Hilscher Gesellschaft für Systemautomation mbH hereby guarantees that the software shall run without errors in accordance with the requirements listed in the specifications and that there were no defects on the date of acceptance. The warranty period shall be 12 months commencing as of the date of acceptance or purchase (with express declaration or implied, by customer's conclusive behavior, e.g. putting into operation permanently).

The warranty obligation for equipment (hardware) we produce is 36 months, calculated as of the date of delivery ex works. The aforementioned provisions shall not apply if longer warranty periods are mandatory by law pursuant to Section 438 (1.2) BGB, Section 479 (1) BGB and Section 634a (1) BGB [Bürgerliches Gesetzbuch; German Civil Code] If, despite of all due care taken, the delivered product should have a defect, which already

existed at the time of the transfer of risk, it shall be at our discretion to either repair the product or to deliver a replacement product, subject to timely notification of defect.

The warranty obligation shall not apply if the notification of defect is not asserted promptly, if the purchaser or third party has tampered with the products, if the defect is the result of natural wear, was caused by unfavorable operating conditions or is due to violations against our operating regulations or against rules of good electrical engineering practice, or if our request to return the defective object is not promptly complied with.

Costs of support, maintenance, customization and product care

Please be advised that any subsequent improvement shall only be free of charge if a defect is found. Any form of technical support, maintenance and customization is not a warranty service, but instead shall be charged extra.

Additional guarantees

Although the hardware and software was developed and tested in-depth with greatest care, Hilscher Gesellschaft für Systemautomation mbH shall not assume any guarantee for the suitability thereof for any purpose that was not confirmed in writing. No guarantee can be granted whereby the hardware and software satisfies your requirements, or the use of the hardware and/or software is uninterrupted or the hardware and/or software is fault-free.

It cannot be guaranteed that patents and/or ownership privileges have not been infringed upon or violated or that the products are free from third-party influence. No additional guarantees or promises shall be made as to whether the product is market current, free from deficiency in title, or can be integrated or is usable for specific purposes, unless such guarantees or promises are required under existing law and cannot be restricted.

Confidentiality

The customer hereby expressly acknowledges that this document contains trade secrets, information protected by copyright and other patent and ownership privileges as well as any related rights of Hilscher Gesellschaft für Systemautomation mbH. The customer agrees to treat as confidential all of the information made available to customer by Hilscher Gesellschaft für Systemautomation mbH and rights, which were disclosed by Hilscher Gesellschaft für Systemautomation mbH and that were made accessible as well as the terms and conditions of this agreement itself.

The parties hereby agree to one another that the information that each party receives from the other party respectively is and shall remain the intellectual property of said other party, unless provided for otherwise in a contractual agreement.

The customer must not allow any third party to become knowledgeable of this expertise and shall only provide knowledge thereof to authorized users as appropriate and necessary. Companies associated with the customer shall not be deemed third parties. The customer must obligate authorized

users to confidentiality. The customer should only use the confidential information in connection with the performances specified in this agreement.

The customer must not use this confidential information to his own advantage or for his own purposes or rather to the advantage or for the purpose of a third party, nor must it be used for commercial purposes and this confidential information must only be used to the extent provided for in this agreement or otherwise to the extent as expressly authorized by the disclosing party in written form. The customer has the right, subject to the obligation to confidentiality, to disclose the terms and conditions of this agreement directly to his legal and financial consultants as would be required for the customer's normal business operation.

Export provisions

The delivered product (including technical data) is subject to the legal export and/or import laws as well as any associated regulations of various countries, especially such laws applicable in Germany and in the United States. The products / hardware / software must not be exported into such countries for which export is prohibited under US American export control laws and its supplementary provisions. You hereby agree to strictly follow the regulations and to yourself be responsible for observing them. You are hereby made aware that you may be required to obtain governmental approval to export, reexport or import the product.

9.5 Registered trademarks

Windows® 10 is a registered trademark of the Microsoft Corporation.

Adobe-Acrobat® is a registered trademark of the Adobe Systems Incorporated.

EtherCAT® is a registered trademark and patented technology, licensed by Beckhoff Automation GmbH, Germany.

EtherNet/IP™ is a trademark of the ODVA (Open DeviceNet Vendor Association, Inc.).

Modbus is a registered trademark of Schneider Electric.

POWERLINK is a registered trademark of B&R, Bernecker + Rainer Industrie-Elektronik Ges.m.b.H, Eggelsberg, Austria.

PROFINET® is a registered trademark of PROFIBUS & PROFINET International (PI), Karlsruhe.

PCI™, PCI Express® and PCIe® or MINI PCI™ are trademarks or registered trademarks of the Peripheral Component Interconnect Special Interest Group (PCI-SIG).

All other brands mentioned are property of their respective owner of the rights. Any company names and product designations provided in this document may be brands (company names or trademarks) of the corresponding owner and may be protected under trademark or patent law.

List of figures

Figure 1:	Basic card CIFX HPCIE90 (Revision 4)	6
Figure 2:	Detached network interface AIFX-V2-RE (revision 2)	7
Figure 3:	Example 2D label	9
Figure 4:	Plug the cable into the cable connector Ethernet on the basic card, example CIFX HPCIE90	20
Figure 5:	Plug the cable into the cable connector fieldbus X1 on the AIFX-V2-RE	21
Figure 6:	Ethernet pin assignment at the RJ45 socket	35
Figure 7:	Connector fieldbus X801 (1x10 pins) on CIFX HPCIE90	37
Figure 8:	Cable connector Ethernet X1 (1x20 pins) on AIFX-V2-RE	38
Figure 9:	Dimensions CIFX HPCIE90 (Revision 4)	51
Figure 10:	Dimensions AIFX-V2-RE (revision 2)	52

List of tables

Table 1:	List of revisions	4
Table 2:	PC card CIFX HPCIE90-RE\F	5
Table 3:	Meaning of the device name.....	5
Table 4:	Legend for the basic card CIFX HPCIE90	6
Table 5:	Legend on the detached network interface AIFX-V2-RE	7
Table 6:	Hardware revisions	8
Table 7:	Driver and software versions	8
Table 8:	Firmware version and file names for permitted protocols	8
Table 9:	Host interface requirements.....	14
Table 10:	Panel cut-outs and holes for AIFX mounting	15
Table 11:	Requirements for operation	16
Table 12:	Overview for installation and firmware download	17
Table 13:	LEDs Real-Time Ethernet systems (duo LEDs and Ethernet LEDs).....	25
Table 14:	LED designations.....	25
Table 15:	States of the SYS-LED	26
Table 16:	Definitions of the states of the SYS LED	26
Table 17:	Communication status EtherCAT Slave	27
Table 18:	Definition LED states communication status	27
Table 19:	Ethernet status EtherCAT Slave	28
Table 20:	Definition LED states Ethernet status	28
Table 21:	Communication status EtherNet/IP Adapter	29
Table 22:	Definition LED states communication status	30
Table 23:	Ethernet status EtherNet/IP Adapter	30
Table 24:	Definition LED states Ethernet status	30
Table 25:	Communication status OpenModbusTCP	31
Table 26:	Definition LED states communication status	31
Table 27:	Ethernet status OpenModbusTCP	31
Table 28:	Definition LED states Ethernet status	31
Table 29:	Communication status POWERLINK Controlled Node.....	32
Table 30:	Definition of LED states communication status	32
Table 31:	Ethernet status POWERLINK Controlled Node	32
Table 32:	Definition of LED state Ethernet status.....	33
Table 33:	Communication status PROFINET IO-Device	34
Table 34:	Definition LED states communication status	34
Table 35:	Ethernet status PROFINET IO-Device	34
Table 36:	Definition LED states Ethernet status	34
Table 37:	Ethernet pin assignment at the RJ45 socket	35
Table 38:	Ethernet connection data 100BASE-TX and 10BASE-T	36
Table 39:	Usability of hubs and switches.....	36

Table 40:	Pin assignment for cable connector Ethernet X801 (BM20B-SRDS-G-T) on CIFS HPCI90	37
Table 41:	Pin assignment for cable connector Ethernet X1 on AIFS-V2-RE	38
Table 42:	Pin assignment Mini PCI Express (H2) bus X201, CIFS HPCI90	39
Table 43:	Technical data CIFS HPCI90-RE\F	41
Table 44:	PCI identifiers on the Mini PCI Express bus	42
Table 45:	Technical data AIFS-V2-RE	43
Table 46:	Technical data EtherCAT Slave	44
Table 47:	Technical data EtherNet/IP Adapter	45
Table 48:	Technical data Open Modbus/TCP	47
Table 49:	POWERLINK Controlled Node	47
Table 50:	Technical data PROFINET IO-Device	48
Table 51:	Signs	55
Table 52:	Signal words	55

Glossary

100BASE-TX	Standard for communication on Ethernet over unshielded twisted pair lines with RJ45 connectors and a Baud_rate of 100 MBit/s (according to the IEEE 802. specification)
10BASE-T	Standard for communication on Ethernet over twisted pair lines with RJ45 connectors and a Baud_rate of 10 MBit/s (according to the IEEE 802.3 specification).
Auto crossover	Auto crossover is a feature of interfaces. An interface with auto-crossover functionality automatically detects and corrects if the data lines are reversed.
Ch0	Ethernet channel 0 (or port 0) of an Ethernet RJ45 socket providing several Ethernet channels
Ch1	Ethernet channel 1 (or port 1) of an Ethernet RJ45 socket with providing Ethernet channels
cifX	Communication InterFace based on netX
CIFX HPCIE90	Communication interface half-Mini PCI-Express from Hilscher based on the communication controller netX 90
DCP	Discovery and basic configuration protocol: Protocol for identifying and configuring devices, which is defined within the PROFINET specification
EtherCAT	Ethernet for Control Automation Technology: communication system for Industrial Ethernet designed and developed by Beckhoff Automation GmbH, Verl, Germany
EtherCAT Slave	Device which is configured by the EtherCAT master, receives data telegrams containing output data, executes commands issued by the EtherCAT master and provides input and status data
EtherNet/IP	Communication system for industrial Ethernet designed and developed by Rockwell that uses the CIP (common industrial protocol)
EtherNet/IP Adapter	Exchanges real-time I/O data with a Scanner Class product and does not initiate connections on its own
Full duplex	Telecommunication system between two partners that enables simultaneous communication in both directions. In such a system, data can be sent even when data is being received simultaneously.
Half duplex	Telecommunication system between two partners that does not allow simultaneous, but only alternating communication in both directions. In such a system, receiving data inhibits the possibility of sending data simultaneously.
Hub	Network component connecting multiple communication partners with each other, but does not provide own intelligence, thus it does not

IP	Internet Protocol: Belongs to the TCP/IP family of protocols and is defined in RFC791 (available on http://www.ietf.org/rfc/rfc791.txt). It is based on layer 3 of the ISO/OSI 7 layer model of networking and is a connectionless protocol, i. e. you do not need to open a connection to a computer before sending an IP data packet to it. Therefore, IP is not able to guarantee that the IP data packets really arrive at the recipient. On IP level, neither the correctness of data nor the consistence and completeness are checked. IP defines special addressing mechanisms; see IP address.
IP address	Identifies a device or a computer within an IP-based network and is defined in the Internet Protocol Version 4 (IPv4) as a 32-bit number. For ease of notation, the address is usually divided into four 8-bit numbers represented in decimal notation and separated by points: a.b.c.d. Each letter stands for an integer value between 0 and 255, e.g. 192.168.30.16. However, not all combinations are allowed, some are reserved for special purposes. The IP address 0.0.0.0 is defined as invalid.
Master	Type of device that initiates and controls the communication on the bus
netX	networX on chip, Hilscher network communication controller. High integrated network controller with optimized system architecture for communication and maximum data transfer.
Open Modbus/TCP	Communication system for Industrial Ethernet designed and developed by Schneider Automation and maintained by the Modbus-IDA organization based on the Modbus protocols for serial communication
POWERLINK	Communication system for industrial Ethernet designed and developed by B&R which also uses CANopen technologies
PROFINET	Communication system for Industrial Ethernet, designed and developed by PROFIBUS & PROFINET International (PI), which uses some mechanisms similar to those of the PROFIBUS field bus
PROFINET IO	PROFINET IO (Input - Output) has been created for the connection of remote peripheral to a controller
PROFINET IO-Device	PROFINET field device that cyclically receives output data from its IO-Controller and responds with its input data
Real-Time Ethernet	Extension of the Ethernet networking technology for industrial purposes with very good Real-Time features and performance also named as 'Industrial Ethernet'. There is a variety of different Real-Time Ethernet systems on the market, which are incompatible with each other. The most important systems are: EtherCAT, EtherNet/IP, POWERLINK, Open Modbus/TCP, PROFINET, Sercos, VARAN.
RJ45	A connector type often used for Ethernet connection. It has been standardized by the Federal Communications Commission of the USA (FCC).
Slave	Type of device that is configured by the master and which then performs the communication

Switch	Intelligent network component connecting multiple communication partners (or even entire branches of a network) with each other, capable to analyze the network traffic in order to decide on its own and shows transparent behaviour to connected communication partners
SYNC	Synchronisation Cycle of the Master

Contacts

HEADQUARTER

Germany

Hilscher Gesellschaft für
Systemautomation mbH
Rheinstraße 15
65795 Hattersheim
Phone: +49 (0) 6190 9907-0
Fax: +49 (0) 6190 9907-50
E-mail: info@hilscher.com

Support

Phone: +49 (0) 6190 9907-990
E-mail: hotline@hilscher.com

SUBSIDIARIES

China

Hilscher Systemautomation (Shanghai) Co. Ltd.
200010 Shanghai
Phone: +86 (0) 21-6355-5161
E-mail: info@hilscher.cn

Support

Phone: +86 (0) 21-6355-5161
E-mail: cn.support@hilscher.com

France

Hilscher France S.a.r.l.
69800 Saint Priest
Phone: +33 (0) 4 72 37 98 40
E-mail: info@hilscher.fr

Support

Phone: +33 (0) 4 72 37 98 40
E-mail: fr.support@hilscher.com

India

Hilscher India Pvt. Ltd.
Pune, Delhi, Mumbai, Bangalore
Phone: +91 8888 750 777
E-mail: info@hilscher.in

Support

Phone: +91 020-24243777
E-mail: info@hilscher.in

Italy

Hilscher Italia S.r.l.
20090 Vimodrone (MI)
Phone: +39 02 25007068
E-mail: info@hilscher.it

Support

Phone: +39 02 25007068
E-mail: it.support@hilscher.com

Japan

Hilscher Japan KK
Tokyo, 160-0022
Phone: +81 (0) 3-5362-0521
E-mail: info@hilscher.jp

Support

Phone: +81 (0) 3-5362-0521
E-mail: jp.support@hilscher.com

Republic of Korea

Hilscher Korea Inc.
13494, Seongnam, Gyeonggi
Phone: +82 (0) 31-739-8361
E-mail: info@hilscher.kr

Support

Phone: +82 (0) 31-739-8363
E-mail: kr.support@hilscher.com

Austria

Hilscher Austria GmbH
4020 Linz
Phone: +43 732 931 675-0
E-mail: sales.at@hilscher.com

Support

Phone: +43 732 931 675-0
E-mail: at.support@hilscher.com

Switzerland

Hilscher Swiss GmbH
4500 Solothurn
Phone: +41 (0) 32 623 6633
E-mail: info@hilscher.ch

Support

Phone: +41 (0) 32 623 6633
E-mail: support.swiss@hilscher.com

USA

Hilscher North America, Inc.
Lisle, IL 60532
Phone: +1 630-505-5301
E-mail: info@hilscher.us

Support

Phone: +1 630-505-5301
E-mail: us.support@hilscher.com