



User Manual

netHOST NHST-T100

LAN controlled master devices for Fieldbus and Real-Time Ethernet Systems



Hilscher Gesellschaft für Systemautomation mbH
www.hilscher.com

DOC130401UM06EN | Revision 6 | English | 2022-12 | Released | Public

Table of contents

1	Introduction	4
1.1	About this document	4
1.1.1	Description of the contents	4
1.1.2	Obligation to read the manual	5
1.1.3	List of revisions	5
1.1.4	Conventions in this document	6
1.1.5	Reference to hardware, firmware, software and drivers	7
1.2	Contents of the product DVD	9
1.3	Documentation overview	11
1.4	Legal notes	15
1.5	Registered Trademarks	18
2	Safety	19
2.1	General note	19
2.2	Intended use	19
2.3	Personnel qualification	19
2.4	Safety references	19
2.5	Safety instructions to avoid personal injury	20
2.5.1	Danger of unsafe system operation	20
2.6	Safety instructions to avoid property damage	20
2.6.1	Device destruction by exceeding allowed supply voltage	20
2.6.2	Danger of unsafe system operation	20
2.7	Labeling of safety messages	21
3	Description	22
3.1	Functionality	22
3.2	Device types	24
3.3	Interfaces	25
4	Requirements	27
5	Device drawings and connectors	29
5.1	Dimensioned drawings	29
5.2	Positions of the LEDs, connectors and control elements	30
5.2.1	netHOST for Fieldbus systems	30
5.2.2	netHOST for Real-Time Ethernet systems	31
5.3	Protocol logo and LED label sticker	32
5.4	Device label	32
5.5	Power supply connector (X1)	32
5.6	Ethernet connectors	33
5.7	Fieldbus interfaces (X3)	34
5.7.1	PROFIBUS DP interface (NHST-T100-DP/DPM)	34
5.7.2	CANopen interface (NHST-T100-CO/COM)	34
5.7.3	DeviceNet interface (NHST-T100-DN/DNM)	35
5.8	USB interface (Mini-B USB)	35
5.9	Schematic diagram of Galvanic isolation	35
5.9.1	netHOST for Fieldbus systems	36

5.9.2	netHOST for RTE systems	37
6	Mounting and dismounting of netHOST device.....	38
6.1	Safety messages.....	38
6.2	Mounting netHOST device onto Top Hat Rail	39
6.3	Removing netHOST device from the Top Hat Rail	40
7	Commissioning.....	41
7.1	Firmware	41
7.2	Configuring the netHOST	41
7.3	Start-up behavior.....	43
7.3.1	Start-up without SD memory card.....	43
7.3.2	Start-up with inserted SD memory card	43
8	Firmware recovery	44
8.1	Overview	44
8.2	Using an SD memory card to reset the netHOST to its “factory settings”	44
8.3	Using USB to recover firmware.....	46
9	Troubleshooting.....	50
10	LEDs.....	51
10.1	SYS LED	51
10.2	APL LED	52
10.3	LEDs of the Fieldbus and Real-Time Ethernet systems	53
10.3.1	LED PROFIBUS DP Master (NHST-T100-DP/DPM).....	53
10.3.2	LED CANopen Master (NHST-T100-CO/COM).....	54
10.3.3	LED DeviceNet Master (NHST-T100-DN/DNM)	55
10.3.4	LEDs PROFINET IO Controller	56
10.3.5	LEDs EtherCAT Master	57
10.3.6	LEDs EtherNet/IP Scanner	59
11	Technical data.....	61
11.1	Technical data of the netHOST devices.....	61
11.1.1	netHOST for Fieldbus systems	61
11.1.2	netHOST for Real-Time Ethernet systems	63
11.2	Technical data of the protocols	64
11.2.1	PROFIBUS DP Master (NHST-T100-DP/DPM).....	64
11.2.2	CANopen Master (NHST-T100-CO/COM).....	65
11.2.3	DeviceNet Master (NHST-T100-DN/DNM)	66
11.2.4	PROFINET IO Controller	67
11.2.5	EtherCAT Master	68
11.2.6	EtherNet/IP Scanner	69
12	Decommissioning/Disposal	70
12.1	Putting the device out of operation.....	70
12.2	Disposal of waste electronic equipment.....	70
	List of figures	71
	List of tables.....	72
	Contacts.....	74

1 Introduction

1.1 About this document

1.1.1 Description of the contents

This user manual describes hardware, installation and commissioning of the LAN controlled Hilscher **netHOST** master devices for fieldbus and Real-Time Ethernet networks:

NHST-T100-DP/DPM for PROFIBUS DP (order no.: 1890.410/DPM)

NHST-T100-CO/COM for CANopen (order no.: 1890.500/COM)

NHST-T100-DN/DNM for DeviceNet (order no.: 1890.510/DNM)

NHST-T100-EN/PNM for PROFINET IO (order no.: 1890.840/PNM)

NHST-T100-EN/ECM for EtherCAT (order no.: 1890.110/ECM)

NHST-T100-EN/EIM for EtherNet/IP (order no.: 1890.820/EIM)

NHST-T100-EN for PROFINET IO, EtherCAT or EtherNet/IP (order no.: 1890.800, hardware and performance are identical to the **NHST-T100-EN/PNM/ECM/EIM** devices, but firmware has to be loaded into the device by the customer)

This document also features the technical data of the devices and of the supported network protocols. Instructions for resetting a netHOST device to its “factory settings” (firmware recovery) are also provided here.

The installation of the configuration software and the configuration of the netHOST devices are not subject of this document.

The installation of the software is described in the user manual *Software Installation netHOST Devices*. Instructions on how to configure, diagnose or test a netHOST device, or how update its firmware are provided in the operating instruction manual *Configuration of LAN controlled master devices – netHOST*.

All devices are delivered with their firmware already installed, except for the **NHST-T100-EN** netHOST device. If you are using the **NHST-T100-EN**, you will find instructions on how to install the firmware in the operating instruction manual *Configuration of LAN controlled master devices – netHOST*.

See also section *Documentation overview* [▶ page 11].

1.1.2 Obligation to read the manual



Important:

- To avoid personal injury or property damage to your system or to your device, you must read and understand all instructions in this manual and in the documents accompanying your device before installing and operating your device.
- First read the **Safety Instructions** in the chapter *Safety* [▶ page 19].
- Observe all **Safety Messages** in this manual.
- Keep the product DVD providing the product manuals.

1.1.3 List of revisions

Index	Date	Revision
1	2013-08-05	Created
2	2014-12-05	Devices for Real-Time Ethernet added, document completely revised. Subtitle of document changed from “ <i>Remote Fieldbus Device for Field Installation</i> ” to „ <i>LAN controlled master devices for Fieldbus and Real-Time Ethernet networks</i> “.
3	2015-07-10	Device NHST-T100-EN for loadable firmware added.
4	2015-07-22	Firmware version in section <i>Hardware and firmware</i> [▶ page 7] updated to version ≥ 1.7 Section <i>LEDs of the Fieldbus and Real-Time Ethernet systems</i> [▶ page 53] updated. Layout of document updated. Layout of safety messages updated.
5	2018-05-16	Software versions in section <i>Software</i> [▶ page 8] updated. Section <i>Legal notes</i> [▶ page 15] updated. Section <i>LEDs EtherCAT Master</i> [▶ page 57] updated. Section <i>LEDs EtherNet/IP Scanner</i> [▶ page 59] updated. Reference to stack version (2.7.) in section <i>Technical data PROFINET IO RT Controller</i> [▶ page 67] updated. Section <i>Technical data EtherCAT Master protocol</i> [▶ page 68] updated (stack version 4.4.) Reference to stack version (2.10.) in section <i>Technical data EtherNet/IP Scanner (master) protocol</i> [▶ page 69] updated.
6	2022-12-08	Section <i>netHOST for Real-Time Ethernet systems</i> [▶ page 31]: Push button at NHST-T100-EN removed. Section <i>Technical data of the netHOST devices</i> [▶ page 61]: UKCA added.

Table 1: List of revisions

1.1.4 Conventions in this document

Notes, operation instructions and results of operation steps are marked as follows:

Notes



Note:

<important note>



Note:

<simple note>



<note, where to find further information>

Operation instructions

1. <operational step>

➤ <instruction>

2. <operational step>

➤ <instruction>

Results

↻ <intermediate result>

⇒ <final result>

For a description of the labeling of **Safety Messages**, see section *Labeling of safety messages* [▶ page 21].

1.1.5 Reference to hardware, firmware, software and drivers

1.1.5.1 Hardware and firmware

This document relates to the following versions of hardware and firmware:

Devices with preloaded firmware

netHOST device preloaded with firmware	Order no.	Hardware revision	Protocol	Firmware file	Firmware (starting from this version and higher)
NHST-T100-DP/DPM	1890.410/DPM	4	PROFIBUS DP Master	FT20V010.NXF	1.7.x.x
NHST-T100-CO/COM	1890.500/COM	4	CANopen Master	FT20V040.NXF	1.7.x.x
NHST-T100-DN/DNM	1890.510/DNM	4	DeviceNet Master	FT20V060.NXF	1.7.x.x
NHST-T100-EN/PNM	1890.840/PNM	2	PROFINET IO Controller	FT20C0V0.NXF	1.7.x.x
NHST-T100-EN/ECM	1890.110/ECM	2	EtherCAT Master	FT20E0V0.NXF	1.7.x.x
NHST-T100-EN/EIM	1890.820/EIM	2	EtherNet/IP Scanner	FT20G0V0.NXF	1.7.x.x

Table 2: Reference to devices with preloaded firmware

Device for loadable firmware

(Firmware not loaded in state of delivery of device):

netHOST device for loadable firmware	Order no.	Hardware revision	Supported protocols	Loadable firmware file	Firmware (starting from this version and higher)
NHST-T100-EN	1890.800	2	PROFINET IO Controller	FT20C0V0.NXF	1.7.x.x
			EtherCAT Master	FT20E0V0.NXF	1.7.x.x
			EtherNet/IP Scanner	FT20G0V0.NXF	1.7.x.x

Table 3: Reference to devices for loadable firmware



Note:

For acting as master device, the **NHST-T100-EN** requires the **NXLIC-Master** license (order no.: **8211.000**). Make sure to order the **NHST-T100-EN** device together with the master license, so that it can be delivered with the license already loaded.

If necessary, a master license can also be ordered and installed belatedly; instructions for this are provided in the operating instruction manual *Configuration of LAN controlled master devices – netHOST*.

1.1.5.2 Software

This document relates to the following software versions:

Software	Version	File name	Path on netHOST Solutions DVD
SYCON.net	1.400.x.x	SYCONnet netX setup.exe	Setups & Drivers\SYCON.net
Ethernet Device Configuration Tool	1.900.x.x	EnDevConfigTool.msi	Setups & Drivers\Ethernet Device Setup Utility
netHOST Device Test Application	1.2.x.x	netHOST.exe	Setups & Drivers\netHOST Test
ComProX	1.0.x.x	comproX.exe	Supplements & Examples\netHOST Device Recovery\Recovery via USB

Table 4: Reference to software

1.1.5.3 Drivers

This document relates to the following driver versions:

Driver	Version	File name	Path on netHOST Solutions DVD
Installation program for Windows USB drivers, <i>contains:</i>	-	setup.exe	Setups & Drivers\USB Driver
• Windows Driver Package hilusbser	6.0.x.x	-	-
• Windows Driver Package hilusbser	6.0.x.x	-	-

Table 5: Reference to drivers

1.2 Contents of the product DVD

The **netHOST Solutions** product DVD contains:

- PDF documentation for users and developers
- SYCON.net configuration and diagnostic program for Windows
- Ethernet Device Configuration Tool for Windows
- netHOST Device Test Application for Windows
- Communication DLLs for immediate usage in customer-engineered Windows applications
- source code of the DLLs
- XML templates and examples for configuring the netHOST device without SYCON.net
- Converter DLL for converting XML text files into netHOST-readable NXD binary files
- C-Toolkit (source code for developers of Non-Windows target platforms and embedded systems)
- USB drivers for Windows (only needed for resetting the device to its factory settings)
- Firmware:
If you are using devices with preloaded firmware, these firmware files are needed only for resetting the device to its factory settings or for firmware recovery in case of a device defect.
If you are using an NHST-T100-EN device (netHOST for loadable firmware), you have to load the corresponding firmware file of the desired protocol into the device during commissioning with SYCON.net.
- Software for resetting the device to its factory settings and for loading firmware
- Video-audio tutorials

Directory of the DVD:

Folder	Contents	
Documentation		
1. Software	Software documentation for standard users (PDF)	
Ethernet Device Setup Utility		
SYCON.net		
2. Hardware	User Manual of the netHOST NHST-T100 device (PDF)	
3. For Programmers		
0.Understanding the Remote Access Principle	Documentation for developers (PDF)	
1.Communication Interface DLL API		
2.C-Toolkit Programming Reference Guide		
3.Shared Memory Interface		
4.Communication Protocol specific APIs		
5.Configuration without SYCON.net, XML file based		Documentation for developers (PDF) and XML files
6.Ethernet Device Scanning UDP Protocol		Documentation for developers (PDF)
7.Error Codes		
4. Installation Instructions	Wiring and software installation instructions for standard users (PDF)	
Firmware		
	Loadable device firmware Note: If you are using devices with preloaded firmware, these firmware files are needed only for resetting the device to its factory settings or for firmware recovery in case of a device defect. If you are using an NHST-T100-EN device (netHOST for loadable firmware), you have to load the corresponding firmware file of the desired protocol into the device during commissioning with SYCON.net.	
fscommand		
	Files needed for displaying the installation menu of the netHOST Solutions DVD	
Programming & Development		
Configuration without SYCON.net, XML file based	XML files	
Generic XML Configuration Schema		
Protocol Specific XML Templates		
XML2NXD Converter DLL		
Developing own remote accessing Applications		
Header Files	Header files for compilation	
netXTransport Protocol C-Toolkit	C source code of the netHOST transport protocol for target platform adaptation	
netXTransport Protocol DLL	C++ source codes of the DLLs and the netHOST Device Test Application for usage under Windows and precompiled Windows DLLs	
Wireshark netXTransport Protocol Interpreter-DLL	DLL files for Wireshark	
Setups & Drivers		
	Installation programs for the SYCON.net configuration and diagnostic software, for the netHOST Device Test Application, for the Ethernet Device Configuration Tool (Ethernet Device Setup Utility) and for the USB drivers	
Supplements & Examples		
netHOST Device Recovery		
Recovery via Memory Card	Images for recovering the factory settings of the device by memory card	

Folder	Contents
Recovery via USB	Software for recovering the factory settings of the device via USB
netXTransport Protocol C-Toolkit - Linux, Win32 Test Applications with Source Code	netXTransport Protocol C-Toolkit - Test Applications.sfx.exe
netXTransport Protocol DLL - Win32 Test Application with Source Code	netHOST test application for Windows
SYCON.net Sample Projects	SYCON.net example projects
XML2NXD Converter - Test Application (WPF) with Source Code	XML2NXD Converter - Test Application.sfx.exe
Training & Podcasts	Video presentations in avi format

Table 6: Directory of netHOST Solutions DVD

1.3 Documentation overview

This section lists documents that are relevant to the user of the netHOST device.

Basic documents

Title	Contents	Document ID	Path on the netHOST Solutions DVD
User Manual netHOST NHST-T100 – LAN controlled master devices for Fieldbus and Real-Time Ethernet Systems (this document)	Installation, commissioning and hardware description of the netHOST devices and other technical data	DOC130401UMxxEN	Documentation\english\2.Hardware\netHOST, Model NHST-T100-xx\netHOST NHST-T100 – LAN controlled master devices UM xx EN.pdf
Operating Instruction Manual Configuration of LAN controlled master devices – netHOST	Configuring, testing, diagnosing and updating firmware of the netHOST devices	DOC130402OIxxEN	Documentation\english\1.Software\SYCON.net Configuration Software\Configuration of netHOST-Devices OI xx EN.pdf
User Manual Software Installation netHOST Devices	Instructions for installing the netHOST software	DOC130501UMxxEN	Documentation\english\4.Installation Instructions \netHOST - Software Installation UM XX EN.pdf
Operating Instruction Manual Ethernet Device Configuration	Instructions on how to assign an IP address to Hilscher devices	DOC050402OIxxEN	Documentation\english\1.Software\Ethernet Device Setup Utility \Ethernet Device Configuration OI XX EN.pdf
User Manual Wiring Instructions	Wiring instructions (cable characteristics) for fieldbus networks	DOC120208UMxxEN	Documentation\english\4.Installation Instructions \Wiring Instructions UM XX EN.pdf

Table 7: Basic documentation for netHOST

netHOST as PROFIBUS DP Master

You also need the following documents if you are using an **NHST-T100-DP/DPM** netHOST device:

Title	Contents	Document ID	Path on the netHOST Solutions DVD
Operating Instruction Manual DTM for Hilscher-PROFIBUS DP Master Devices	Description of the device type manager for PROFIBUS DP master devices	DOC070401OIxxEN	Documentation\english\1.Software\SYCON.net Configuration Software\Master Configuration \PROFIBUS DP Master\PROFIBUS DP Master DTM OI xx EN.pdf
Operating Instruction Manual Generic Slave DTM for PROFIBUS DP Slave Devices	Description of the device type manager for generic PROFIBUS DP slave devices	DOC031001OIxxEN	Documentation\english\1.Software\SYCON.net Configuration Software\Master Configuration \PROFIBUS DP Master\Slave Configuration \PROFIBUS DP Generic Slave DTM OI xx EN.pdf

Table 8: Additional documentation for netHOST as PROFIBUS DP Master

netHOST as CANopen Master

You also need the following documents if you are using an **NHST-T100-CO/COM** netHOST device:

Title	Contents	Document ID	Path on the netHOST Solutions DVD
Operating Instruction Manual DTM for Hilscher-CANopen Master Devices	Description of the device type manager for CANopen master devices	DOC070402OIxxEN	Documentation\english\1.Software\SYCON.net Configuration Software\Master Configuration \CANopen Master\CANopen Master DTM OI xx EN.pdf
Operating Instruction Manual Generic Slave DTM for CANopen Slave Devices	Description of the device type manager for generic CANopen slave devices	DOC060203OIxxEN	Documentation\english\1.Software\SYCON.net Configuration Software\Master Configuration \CANopen Master\Slave Configuration\CANopen Generic Slave DTM OI xx EN.pdf

Table 9: Additional documentation for netHOST as CANopen Master

netHOST as DeviceNet Master

You also need the following documents, if you are using an **NHST-T100-DN/DNM** netHOST device:

Title	Contents	Document ID	Path on the netHOST Solutions DVD
Operating Instruction Manual DTM for Hilscher-DeviceNet Master Devices	Description of the device type manager for DeviceNet master devices	DOC070403OIxxEN	Documentation\english\1.Software\SYCON.net Configuration Software\Master Configuration \DeviceNet Master\DeviceNet Master DTM OI xx EN.pdf
Operating Instruction Manual Generic Slave DTM for DeviceNet Slave Devices	Description of the device type manager for generic DeviceNet slave devices	DOC041201OIxxEN	Documentation\english\1.Software\SYCON.net Configuration Software\Master Configuration \DeviceNet Master\Slave Configuration\DeviceNet Generic Slave DTM OI xx EN.pdf

Table 10: Additional documentation for netHOST as DeviceNet Master

netHOST as PROFINET IO Controller

You also need the following documents if you are using an **NHST-T100-EN/PNM**, respectively **NHST-T100-EN** device with loaded PROFINET IO Controller firmware:

Title	Contents	Document ID	Path on the netHOST Solutions DVD
Operating Instruction Manual DTM for Hilscher-PROFINET IO-Controller Devices	Description of the device type manager for PROFINET IO Controller devices	DOC060302OIxxEN	Documentation\english\1.Software\SYCON.net Configuration Software\Master Configuration \PROFINET IO Controller\PROFINET IO Controller DTM OI xx EN.pdf
Operating Instruction Manual Generic DTM for PROFINET IO Devices	Description of the device type manager for generic PROFINET IO devices	DOC060305OIxxEN	Documentation\english\1.Software\SYCON.net Configuration Software\Master Configuration \PROFINET IO Controller \IO Device Configuration \PROFINET IO Generic Device DTM OI xx EN.pdf

Table 11: Additional documentation for netHOST as PROFINET IO Controller

netHOST as EtherCAT Master

You also need the following documents if you are using an **NHST-T100-EN/ECM**, respectively **NHST-T100-EN** device with loaded EtherCAT Master firmware:

Title	Contents	Document ID	Path on the netHOST Solutions DVD
Operating Instruction Manual DTM for Hilscher EtherCAT Master Device	Description of the device type manager for EtherCAT Master devices	DOC080404OIxxEN	Documentation\english\1.Software\SYCON.net Configuration Software\Master Configuration \EtherCAT Master\EtherCAT Master DTM OI xx EN.pdf
Operating Instruction Manual Generic Slave DTM for EtherCAT Slave Devices	Description of the device type manager for generic EtherCAT slave devices	DOC071202OIxxEN	Documentation\english\1.Software\SYCON.net Configuration Software\Master Configuration \EtherCAT Master\Slave Configuration\EtherCAT Generic Slave DTM OI xx EN.pdf
User Manual Wiring Instructions EtherCAT	Wiring instructions for EtherCAT networks	DOC121104UMxxEN	Documentation\english\4.Installation Instructions\Wiring Instructions UM xx EN.pdf

Table 12: Additional documentation for netHOST as EtherCAT Master

netHOST as EtherNet/IP Scanner

You also need the following documents if you are using an **NHST-T100-EN/EIM**, respectively **NHST-T100-EN** device with loaded EtherNet/IP Scanner firmware:

Title	Contents	Document ID	Path on the netHOST Solutions DVD
Operating Instruction Manual DTM for EtherNet/IP Scanner Devices	Description of the device type manager for EtherNet/IP Scanner devices	DOC061201OIxxEN	Documentation\english\1.Software\SYCON.net Configuration Software\Master Configuration \EtherNetIP Scanner\EtherNetIP Scanner DTM OI xx EN.pdf
Operating Instruction Manual Generic, Modular Generic DTM from EDS File for non-modular and modular EtherNet/IP Adapter Devices	Description of the generic, modular generic device type manager from EDS file for non-modular EtherNet/IP Adapter devices and modular EtherNet/IP Adapter devices	DOC100221OIxxEN	Documentation\english\1.Software\SYCON.net Configuration Software\Master Configuration \EtherNetIP Scanner\Adapter Configuration \EtherNetIP Generic Adapter DTM EDS OI xx EN.pdf
Operating Instruction Manual Generic DTM for EtherNet/IP Adapter Devices and Modular Generic DTM for modular EtherNet/IP Adapter Devices	Description of the generic device type manager for EtherNet/IP Adapter devices and modular EtherNet/IP Adapter devices	DOC070203OIxxEN	Documentation\english\1.Software\SYCON.net Configuration Software\Master Configuration \EtherNetIP Scanner\Adapter Configuration \EtherNetIP Generic Adapter DTM OI xx EN.pdf

Table 13: Additional documentation for netHOST as EtherNet/IP Scanner

1.4 Legal notes

Copyright

© Hilscher Gesellschaft für Systemautomation mbH

All rights reserved.

The images, photographs and texts in the accompanying materials (in the form of a user's manual, operator's manual, Statement of Work document and all other document types, support texts, documentation, etc.) are protected by German and international copyright and by international trade and protective provisions. Without the prior written consent, you do not have permission to duplicate them either in full or in part using technical or mechanical methods (print, photocopy or any other method), to edit them using electronic systems or to transfer them. You are not permitted to make changes to copyright notices, markings, trademarks or ownership declarations. Illustrations are provided without taking the patent situation into account. Any company names and product designations provided in this document may be brands or trademarks by the corresponding owner and may be protected under trademark, brand or patent law. Any form of further use shall require the express consent from the relevant owner of the rights.

Important notes

Utmost care was/is given in the preparation of the documentation at hand consisting of a user's manual, operating manual and any other document type and accompanying texts. However, errors cannot be ruled out. Therefore, we cannot assume any guarantee or legal responsibility for erroneous information or liability of any kind. You are hereby made aware that descriptions found in the user's manual, the accompanying texts and the documentation neither represent a guarantee nor any indication on proper use as stipulated in the agreement or a promised attribute. It cannot be ruled out that the user's manual, the accompanying texts and the documentation do not completely match the described attributes, standards or any other data for the delivered product. A warranty or guarantee with respect to the correctness or accuracy of the information is not assumed.

We reserve the right to modify our products and the specifications for such as well as the corresponding documentation in the form of a user's manual, operating manual and/or any other document types and accompanying texts at any time and without notice without being required to notify of said modification. Changes shall be taken into account in future manuals and do not represent an obligation of any kind, in particular there shall be no right to have delivered documents revised. The manual delivered with the product shall apply.

Under no circumstances shall Hilscher Gesellschaft für Systemautomation mbH be liable for direct, indirect, ancillary or subsequent damage, or for any loss of income, which may arise after use of the information contained herein.

Liability disclaimer

The hardware and/or software was created and tested by Hilscher Gesellschaft für Systemautomation mbH with utmost care and is made available as is. No warranty can be assumed for the performance or flawlessness of the hardware and/or software under all application conditions and scenarios and the work results achieved by the user when using the hardware and/or software. Liability for any damage that may have occurred as a result of using the hardware and/or software or the corresponding documents shall be limited to an event involving willful intent or a grossly negligent violation of a fundamental contractual obligation. However, the right to assert damages due to a violation of a fundamental contractual obligation shall be limited to contract-typical foreseeable damage.

It is hereby expressly agreed upon in particular that any use or utilization of the hardware and/or software in connection with

- Flight control systems in aviation and aerospace;
- Nuclear fission processes in nuclear power plants;
- Medical devices used for life support and
- Vehicle control systems used in passenger transport

shall be excluded. Use of the hardware and/or software in any of the following areas is strictly prohibited:

- For military purposes or in weaponry;
- For designing, engineering, maintaining or operating nuclear systems;
- In flight safety systems, aviation and flight telecommunications systems;
- In life-support systems;
- In systems in which any malfunction in the hardware and/or software may result in physical injuries or fatalities.

You are hereby made aware that the hardware and/or software was not created for use in hazardous environments, which require fail-safe control mechanisms. Use of the hardware and/or software in this kind of environment shall be at your own risk; any liability for damage or loss due to impermissible use shall be excluded.

Warranty

Hilscher Gesellschaft für Systemautomation mbH hereby guarantees that the software shall run without errors in accordance with the requirements listed in the specifications and that there were no defects on the date of acceptance. The warranty period shall be 12 months commencing as of the date of acceptance or purchase (with express declaration or implied, by customer's conclusive behavior, e.g. putting into operation permanently).

The warranty obligation for equipment (hardware) we produce is 36 months, calculated as of the date of delivery ex works. The aforementioned provisions shall not apply if longer warranty periods are mandatory by law pursuant to Section 438 (1.2) BGB, Section 479 (1) BGB and Section 634a (1) BGB [Bürgerliches Gesetzbuch; German Civil Code] If, despite of all due care taken, the delivered product should have a defect, which already

existed at the time of the transfer of risk, it shall be at our discretion to either repair the product or to deliver a replacement product, subject to timely notification of defect.

The warranty obligation shall not apply if the notification of defect is not asserted promptly, if the purchaser or third party has tampered with the products, if the defect is the result of natural wear, was caused by unfavorable operating conditions or is due to violations against our operating regulations or against rules of good electrical engineering practice, or if our request to return the defective object is not promptly complied with.

Costs of support, maintenance, customization and product care

Please be advised that any subsequent improvement shall only be free of charge if a defect is found. Any form of technical support, maintenance and customization is not a warranty service, but instead shall be charged extra.

Additional guarantees

Although the hardware and software was developed and tested in-depth with greatest care, Hilscher Gesellschaft für Systemautomation mbH shall not assume any guarantee for the suitability thereof for any purpose that was not confirmed in writing. No guarantee can be granted whereby the hardware and software satisfies your requirements, or the use of the hardware and/or software is uninterrupted or the hardware and/or software is fault-free.

It cannot be guaranteed that patents and/or ownership privileges have not been infringed upon or violated or that the products are free from third-party influence. No additional guarantees or promises shall be made as to whether the product is market current, free from deficiency in title, or can be integrated or is usable for specific purposes, unless such guarantees or promises are required under existing law and cannot be restricted.

Confidentiality

The customer hereby expressly acknowledges that this document contains trade secrets, information protected by copyright and other patent and ownership privileges as well as any related rights of Hilscher Gesellschaft für Systemautomation mbH. The customer agrees to treat as confidential all of the information made available to customer by Hilscher Gesellschaft für Systemautomation mbH and rights, which were disclosed by Hilscher Gesellschaft für Systemautomation mbH and that were made accessible as well as the terms and conditions of this agreement itself.

The parties hereby agree to one another that the information that each party receives from the other party respectively is and shall remain the intellectual property of said other party, unless provided for otherwise in a contractual agreement.

The customer must not allow any third party to become knowledgeable of this expertise and shall only provide knowledge thereof to authorized users as appropriate and necessary. Companies associated with the customer shall not be deemed third parties. The customer must obligate authorized

users to confidentiality. The customer should only use the confidential information in connection with the performances specified in this agreement.

The customer must not use this confidential information to his own advantage or for his own purposes or rather to the advantage or for the purpose of a third party, nor must it be used for commercial purposes and this confidential information must only be used to the extent provided for in this agreement or otherwise to the extent as expressly authorized by the disclosing party in written form. The customer has the right, subject to the obligation to confidentiality, to disclose the terms and conditions of this agreement directly to his legal and financial consultants as would be required for the customer's normal business operation.

Export provisions

The delivered product (including technical data) is subject to the legal export and/or import laws as well as any associated regulations of various countries, especially such laws applicable in Germany and in the United States. The products / hardware / software must not be exported into such countries for which export is prohibited under US American export control laws and its supplementary provisions. You hereby agree to strictly follow the regulations and to yourself be responsible for observing them. You are hereby made aware that you may be required to obtain governmental approval to export, reexport or import the product.

1.5 Registered Trademarks

Adobe Reader® is a registered trademark of the Adobe Systems Incorporated.

CANopen® is a registered trademark of CAN in AUTOMATION - International Users and Manufacturers Group e.V (CiA), Nürnberg.

DeviceNet™ and EtherNet/IP™ are trademarks of ODVA (Open DeviceNet Vendor Association, Inc).

EtherCAT® is a registered trademark and patented technology, licensed by Beckhoff Automation GmbH, Germany.

PROFIBUS® and PROFINET® are registered trademarks of PROFIBUS & PROFINET International (PI), Karlsruhe.

Windows® XP, Windows® Vista, Windows® 7 and Windows® 8 are registered trademarks of the Microsoft Corporation.

All other mentioned trademarks are property of their respective legal owners.

2 Safety

2.1 General note

The user manual, the accompanying texts and the documentation are written for the use of the products by educated personnel. When using the products, all safety instructions and all valid legal regulations have to be obeyed. Technical knowledge is presumed. The user has to assure that all legal regulations are obeyed.

2.2 Intended use

The netHOST devices described in this manual are communication devices which connect a TCP/IP network to a fieldbus or Real-Time Ethernet network. The netHOST devices thus serve as “gateways” between the two networks.

The netHOST devices are in a compact housing and suitable for DIN rail mounting according to DIN EN 60715.

2.3 Personnel qualification

The netHOST devices must only be installed, configured and removed by qualified personnel. Job-specific technical skills for people professionally working with electricity must be present concerning the following topics:

- Safety and health at work
- Mounting and attaching of electrical equipment
- Measurement and analysis of electrical functions and systems
- Evaluation of the safety of electrical systems and equipment
- Installing and configuring IT

2.4 Safety references

- [S1] American National Standards Institute, Inc.: American National Standard, Product Safety Information in Product Manuals, Instructions, and Other Collateral Materials, ANSI Z535.6-2016, English, 2016.
- [S2] DIN Deutsches Institut für Normung e. v. and VDE Verband der Elektrotechnik Elektronik Informationstechnik e. V.: German standard, Equipment for audio/video, information and communication technology - Part 1: Safety requirements, (IEC 62368-1:2014, modified + Cor.:2015); English version EN 62368-1:2014 + AC:2015, English, 2016-05.
- [S3] DIN Deutsches Institut für Normung e. v. and VDE Verband der Elektrotechnik Elektronik Informationstechnik e. V.: German standard, Electrostatics - Part 5-1: Protection of electronic components against electrostatic phenomena, General requirements, (IEC 61340-5-1:2016); English version EN 61340-5-1:2016, English, 2017-07.
- DIN Deutsches Institut für Normung e. v. and VDE Verband der Elektrotechnik Elektronik Informationstechnik e. V.: German standard, Electrostatics - Part 5-2: Protection of electronic components against electrostatic phenomena, User manual, (IEC TR 61340-5-2:2018), DIN IEC/TR 61340-5-2 (VDE V 0300-5-2), English, 2019-04.

2.5 Safety instructions to avoid personal injury

To ensure your own personal safety and to avoid personal injury, you must read, understand and follow the safety instructions and all safety messages in this manual about danger that might cause personal injury, before you install and operate your netHOST device.

2.5.1 Danger of unsafe system operation

To prevent personal injury, make sure that the removal of the device from your plant during operation will not affect the safe operation of the plant.

2.6 Safety instructions to avoid property damage

To avoid property damage to your system or to the netHOST device, you must read, understand and follow the safety instructions and all safety messages in this manual about danger that might cause property damage, before you install and operate your netHOST device.

2.6.1 Device destruction by exceeding allowed supply voltage

Observe the following notes concerning the supply voltage:

- The netHOST may only be operated with the specified supply voltage. Make sure that the limits of the allowed range for the supply voltage are not exceeded.
- A supply voltage above the upper limit can cause severe damage to the netHOST!
- A supply voltage below the lower limit can cause malfunction of the netHOST.

The allowed range for the supply voltage is specified in the section *Technical data of the netHOST devices* [▶ page 61].

2.6.2 Danger of unsafe system operation

To prevent property damage, make sure that the removal of the device from your plant during operation will not affect safe operation of the plant.

2.7 Labeling of safety messages

In this document the safety instructions and property damage messages are designed according both to the internationally used safety conventions as well as to the **ANSI Z535** standard.

- The **Section Safety Messages** at the beginning of a chapter are pinpointed particularly and highlighted by a signal word according to the degree of endangerment. The kind of danger is specified exactly by the safety message text and optionally by a specific safety sign.
- The **Integrated Safety Messages** embedded in operating instructions are highlighted by a signal word according to the degree of endangerment. In the safety message, the nature of the hazard is indicated.

Signal words and safety signs in safety messages on personal injury



Signal word	Meaning
 DANGER	Indicates a direct hazard with high risk, which will have as consequence death or grievous bodily harm if it is not avoided.
 WARNING	Indicates a possible hazard with medium risk, which will have as consequence death or (grievous) bodily harm if it is not avoided.
 CAUTION	Indicates a minor hazard with medium risk, which could have as consequence personal injury if it is not avoided.

Table 14: Signal words in safety messages on personal injury



Safety sign	Sort of warning or principle
	Warning of lethal electrical shock
	Principle: Disconnect the power plug

Table 15: Safety signs in messages on personal injury

Signal words and safety signs in safety messages on property damage

Signal word	Meaning
 NOTICE	Indicates a property damage message

Table 16: Signal words in safety messages on property damage

Safety sign	Sort of warning or principle
	Warning of property damage by electrostatic discharge

Table 17: Safety signs in safety messages on property damage

3 Description

3.1 Functionality

The Hilscher netHOST is a communication device that connects a TCP/IP network to a fieldbus or Real-Time Ethernet (RTE) network. The netHOST device has a compact housing and is suited for DIN rail mounting according to DIN EN 60715.

The netHOST device allows you to access data of a fieldbus or Real-Time Ethernet network from your PC, terminal or other host system via TCP/IP. Thus, the device serves as a gateway, respectively programming interface between your PC/terminal/host system and the fieldbus or RTE network. Once configured, the netHOST device controls the secondary network on its own.

An appropriate application program establishes the TCP/IP connection to the device and accesses the data of the fieldbus/RTE network.

Access to the netHOST device takes place according to the "Ethernet Marshalling" procedures, by which locally generated service requests of an initiator (i. e. the host application) are being transmitted to a receiver (i. e. the netHOST device) by an appropriate method (i. e. coded/decoded in Ethernet telegrams). The service requests are then called and executed "remotely" on the netHOST device.

The host system can be based on a Windows operating system, but is, however, not restricted to Windows only. For Windows developers, the netHOST Solutions DVD provides the code with the Ethernet Marshalling function both as C++ source code and as Windows DLL (netXTransport.dll). For developers of embedded systems, the DVD provides a C source code which is independent from any specific type of operating system.

**Important:**

The Ethernet LAN connection to the netHOST device is not protected by password or encryption. Protection against unauthorized access by external networks has to be ensured by using adequate measures !

The following figure illustrates the data flow of “Ethernet Marshalling” with the netHOST:

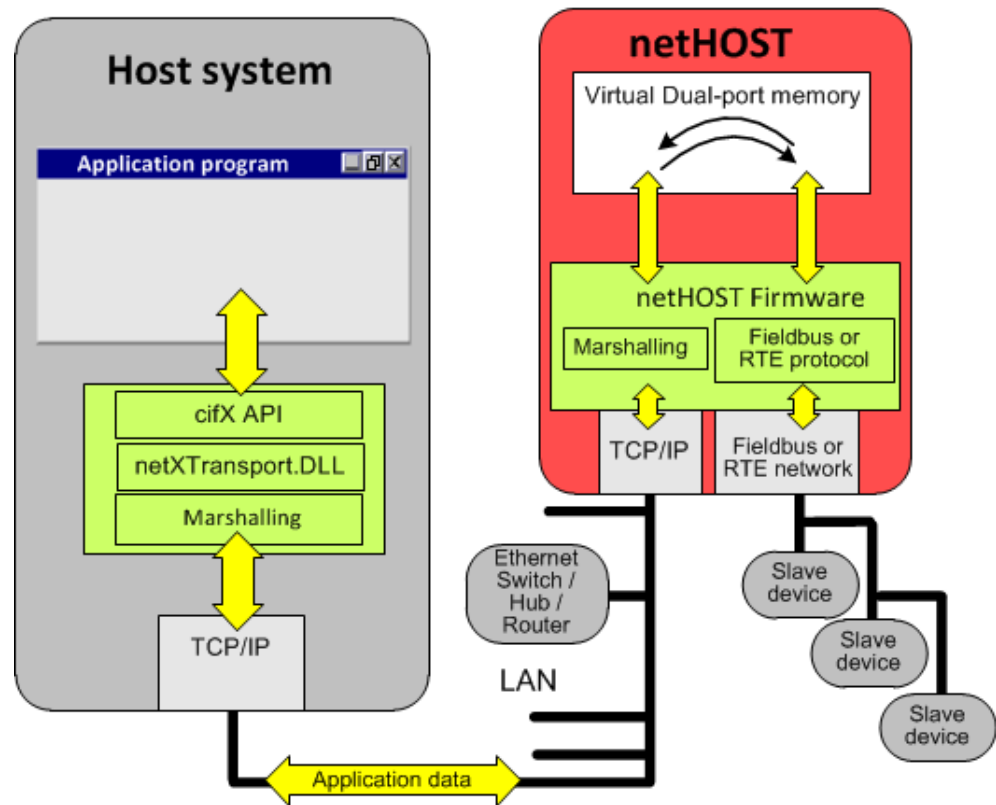

Figure 1: Data flow of LAN controlled netHOST device

3.2 Device types

Devices with preloaded firmware

LAN controlled netHOSTs are currently available as **master devices** for the following protocols:

- PROFIBUS DP (**NHST-T100-DP/DPM**),
- CANopen (**NHST-T100-CO/COM**),
- DeviceNet (**NHST-T100-DN/DNM**),
- PROFINET IO (**NHST-T100-EN/PNM**),
- EtherCAT (**NHST-T100-EN/ECM**),
- EtherNet/IP (**NHST-T100-EN/EIM**)

netHOSTs acting as **slave devices** in the secondary network are not yet available.

All devices listed above are delivered with their firmware and master license already loaded.

Device for loadable firmware

To allow users of Real-Time Ethernet system more flexibility, Hilscher also offers the device

- **NHST-T100-EN**

which has the same hardware and performance as the other netHOST devices for Real-Time Ethernet listed above (**NHST-T100-EN/PNM/ECMEIM**), but it is not delivered with preloaded firmware. For this device, the product DVD provides firmware files for the

- PROFINET IO Controller,
- EtherCAT Master and
- EtherNet/IP Scanner

protocols, which can be chosen and downloaded to the **NHST-T100-EN** by the user himself, the device supporting each of these three protocols. To act as a master, the **NHST-T100-EN** also needs the **NXLIC-Master** license. If you order the **NHST-T100-EN** together with the **NXLIC-Master** license (order no. **8211.000**), the device will be delivered with an already installed and activated master license – you will thus only have to download the chosen firmware file.

A belated ordering and downloading of a master license after device delivery is also possible, information on this can be found in the operating instruction manual *Configuration of LAN controlled master devices – netHOST*.

3.3 Interfaces

All interfaces are easily accessible at the front of the netHOST device. In addition to the necessary network interfaces, every device is also equipped with a USB interface (protected by a cover) and an SD memory card slot. The USB and SD memory card interfaces can be used to perform a firmware recovery or to reset the device to its “factory settings” (see chapter *Firmware-Recovery* [▶ page 44]).

netHOST for Fieldbus systems

The netHOST devices **NHST-T100-DP/DPM**, **NHST-T100-CO/COM** and **NHST-T100-DN/DNM** are equipped with two RJ45 sockets on the left side (**X2**), in order to connect the device to the LAN network by which the netHOST is controlled/marshalled. The interface for the Fieldbus (i. e. the secondary network), which is to be controlled by the netHOST, is located on the right side of the device (**X3**) and consists of a PROFIBUS DP, CANopen or DeviceNet interface and the appropriate fieldbus connector hardware (according to the device type).

The following figure shows the NHST-T100-DP/DPM netHOST device:

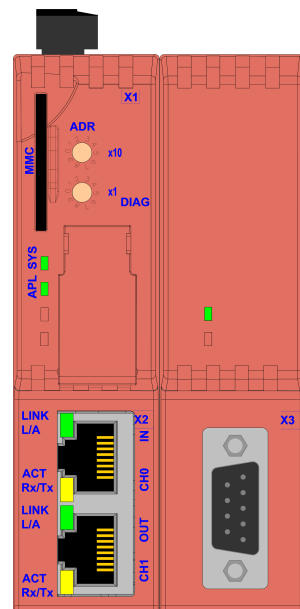

Figure 2: netHOST for Fieldbus: NHST-T100-DP/DPM (example)

netHOST for Real-Time Ethernet systems

The netHOST devices **NHST-T100-EN**, **NHST-T100-EN/PNM**, **NHST-T100-EN/ECM** and **NHST-T100-EN/EIM** are equipped with three RJ45 sockets. The two RJ45 sockets for the Real-Time Ethernet system, which is to be controlled by the netHOST, are located on the left side of the device (**X2**). A single RJ45 socket for the LAN network, by which the netHOST is controlled/marshalled, is located on the right side of the device (**X3**).

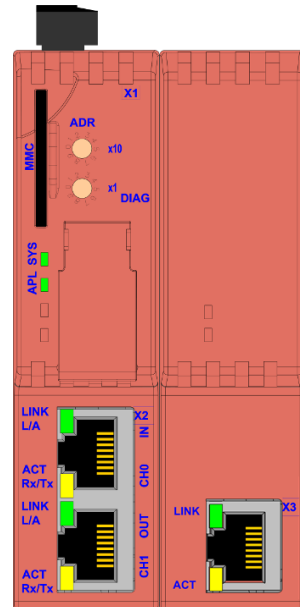

Figure 3: netHOST for RTE systems

4 Requirements

Technical requirements

- The netHOST device is to be mounted on a DIN rail according to DIN EN 60715.
- A suitable external power supply is required.
- The voltage to be applied must be in the allowed range $24\text{ V} \pm 6\text{ V DC}$.
- The power supply must be able to deliver at least a current of 130 mA at 24 V.
- Power supply is to be connected at the X1 connector located on the upper side of the device (see section *Positions of the LEDs, connectors and control elements* [▶ page 30]).

NOTICE

Device Destruction by Exceeding Allowed Supply Voltage!

The voltage must not exceed 30 V, otherwise the device may be destroyed or damaged.

In order to avoid damage caused by overheating or freezing, it is necessary that the temperature of the device does not exceed the limits of the allowed temperature range. For the allowed temperature, see section *Technical data of the netHOST devices* [▶ page 61].

General requirements

Additionally, the following preconditions must be met in order to operate the netHOST device successfully:

- If you are using an **NHST-T100-EN** netHOST device (order no. 1890.800) you must download the firmware to the device before commissioning/configuring the netHOST.
- An IP address must be assigned to the netHOST device (by default/factory setting, the IP address of the netHOST is 0.0.0.0).
- The netHOST device must be properly configured with the SYCON.net configuration software. The configuration needs to be downloaded to the device. As an alternative, the netHOST can also be configured by the accessing host system.



For detailed information on how download firmware to the **NHST-T100-EN** device and how to configure all netHOST devices with SYCON.net, see Operating Instruction Manual *Configuration of LAN controlled master devices – netHOST*, DOC1304020IxxEN, stored on the netHOST Solutions DVD in the Documentation\english \1.Software\SYCON.net directory.

Requirements for using the SYCON.net configuration software

For installing and operating the SYCON.net configuration software, you need the following:

- PC with 1 GHz processor or higher
- Windows® XP SP3, Windows® Vista (32 bit) SP2, Windows® 7 (32 bit) SP1, Windows® 7 (64 bit) SP1, Windows® 8 (32 bit) or Windows® 8 (64 bit)
- Administrator privilege required for installation
- Internet Explorer 5.5 or higher
- Free disk space: min. 400 MByte
- DVD ROM drive
- RAM: min. 512 MByte, recommended 1024 MByte
- Graphic resolution: min. 1024 x 768 pixel
- Keyboard and Mouse
- Ethernet interface

**Note:**

If the project file is saved and opened again or it is used on another PC, the system requirements need to match. Particularly the DTMs need to be installed on the used PC.

Restrictions

Touch screen is not supported.

5 Device drawings and connectors

5.1 Dimensioned drawings

The outer dimensions are identical for all types of netHOST devices.

Side view:

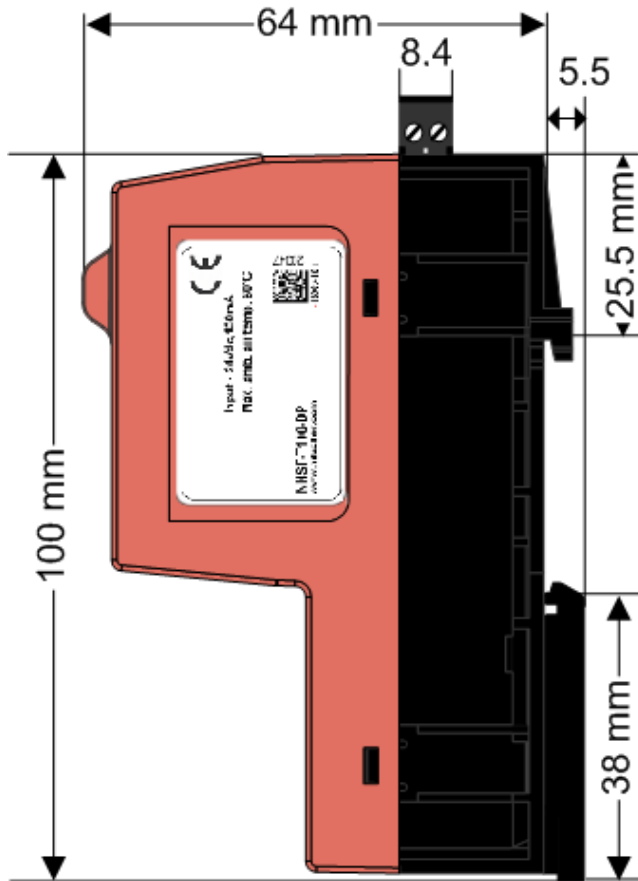

Front view:

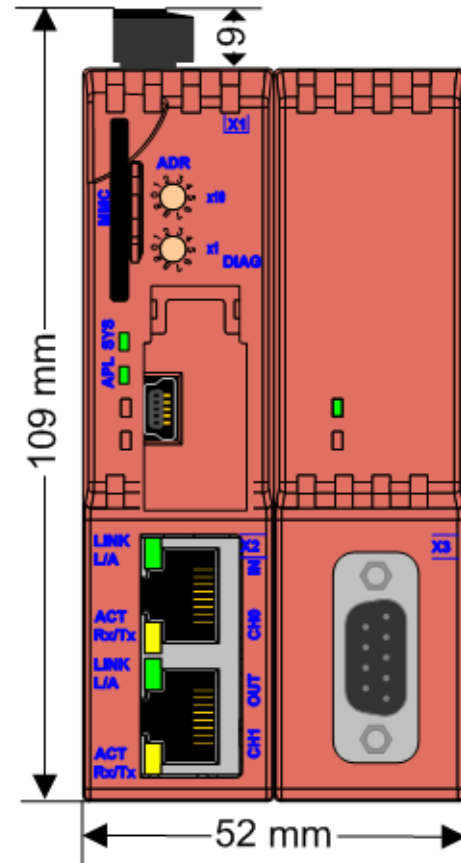

Power supply plug:

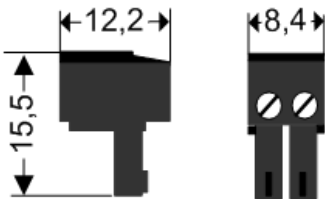

Table 18: Dimensioned drawing, example NHST-T100-DP



Important:

When planning the installation of the netHOST device, take into account that there must be enough head room above the device to allow for convenient plugging and unplugging of the power supply.

5.2 Positions of the LEDs, connectors and control elements

5.2.1 netHOST for Fieldbus systems

The following figure depicts LEDs, connectors and control elements of the netHOST for Fieldbus systems. The left part of each netHOST is identical for all device types, the right part differs according to fieldbus type.

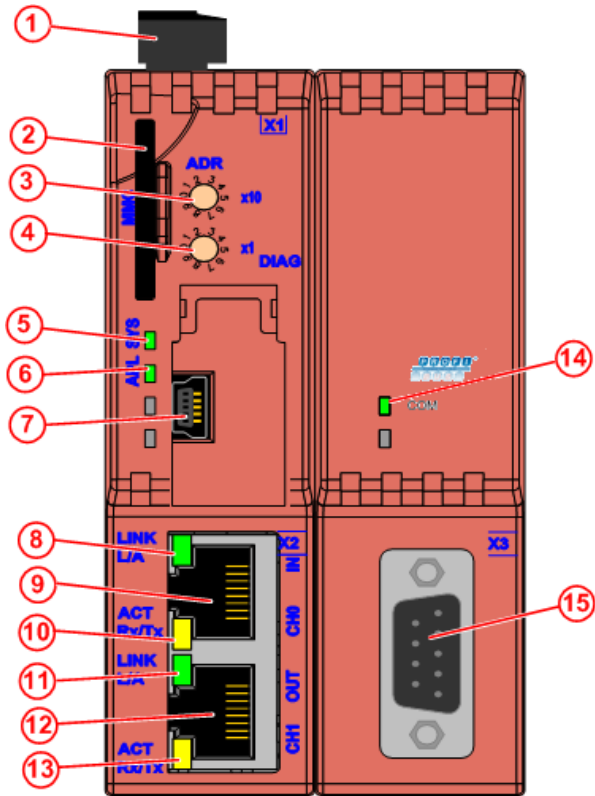

- (1) Connector for supply voltage (X1)
- (2) Slot for SD memory card (part number 1719.003)
- (3) Address switch (factor 10), can be monitored in the system information block.
- (4) Address switch (factor 1), can be monitored in the system information block.
- (5) SYS LED (system status)
- (6) APL LED (application status)
- (7) Mini USB service interface (protected by a cover)
- (8) LINK LED for LAN channel 0
- (9) LAN interface channel 0 (X2, RJ45 socket)
- (10) ACT LED for LAN channel 0 (activity)
- (11) LINK LED for LAN channel 1
- (12) LAN interface channel 1 (X2, RJ45 socket)
- (13) ACT LED for LAN channel 1 (activity)
- (14) **LED communication status of fieldbus**
 PROFIBUS DP Master (NHST-T100-DP):
COM
 CANopen Master (NHST-T100-CO):
CAN
 DeviceNet Master (NHST-T100-DN):
MNS
- (15) **Fieldbus interface (X3)**
 PROFIBUS DP Master (NHST-T100-DP):
 Dsub 9-pole female
 CANopen Master (NHST-T100-CO):
 Dsub 9-pole male
 DeviceNet Master (NHST-T100-DN):
 COMBICON 5-pole

NHST-T100-DP

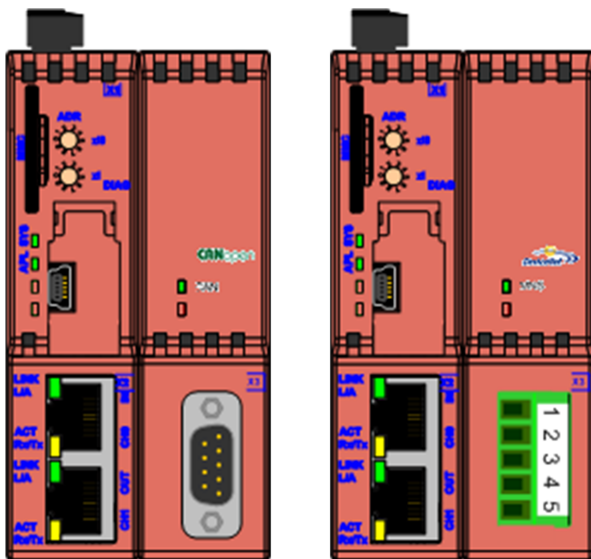

NHST-T100-CO

NHST-T100-DN

Table 19: LEDs, connectors and operating elements of netHOST for Fieldbus systems

5.2.2 netHOST for Real-Time Ethernet systems

The following figure depicts LEDs, connectors and control elements of the netHOST for Real-Time Ethernet systems.

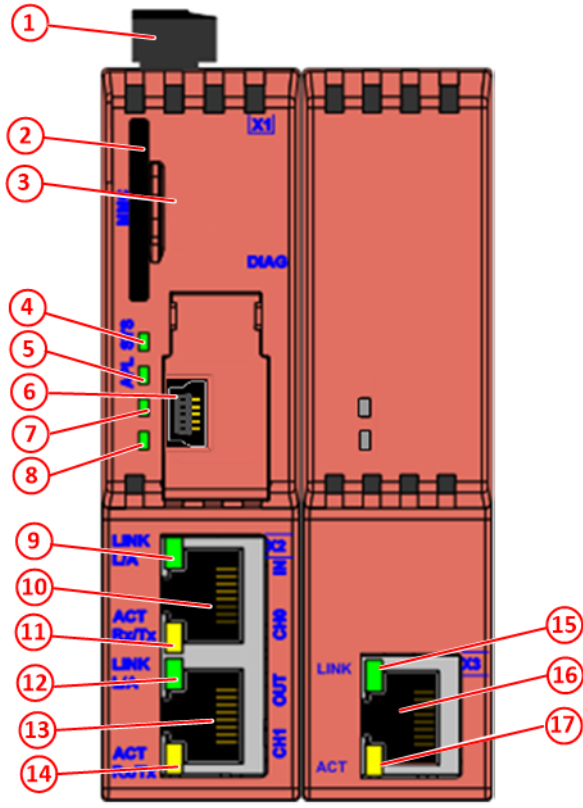

NHST-T100-EN

- (1) Connector for supply voltage (X1)
- (2) Slot for SD memory card (part number 1719.003)
- (3) Current hardware revision: -
Previous hardware revisions: Push button without function
- (4) SYS LED (system status)
- (5) APL LED (application status)
- (6) Mini USB service interface (protected by a cover)
- (7) Protocol specific LED
for PROFINET IO Controller: **SF**
for EtherCAT Master: **RUN**
for EtherNet/IP Scanner: **MS**
- (8) Protocol specific LED
for PROFINET IO Controller: **BF**
for EtherCAT Master: **ERR**
for EtherNet/IP Scanner: **NS**
- (9) LINK LED for Real-Time Ethernet channel 0
- (10) Real-Time Ethernet interface channel 0 (X2, RJ45 socket)
- (11) ACT LED for Real-Time Ethernet channel 0 (activity)
- (12) LINK LED for Real-Time Ethernet channel 1
- (13) Real-Time Ethernet interface channel 1 (X2, RJ45 socket)
- (14) ACT LED for Real-Time Ethernet channel 1 (activity)
- (15) LINK LED for LAN interface
- (16) LAN interface (X3, RJ45 socket)
- (17) ACT LED for LAN interface (activity)

Table 20: LEDs, connectors and operating elements of netHOST for RTE systems

5.3 Protocol logo and LED label sticker

Each netHOST with preloaded firmware is delivered with the appropriate protocol logo and LED labels already attached to the device. In case of the **NHST-T100-EN** device (for which the appropriate firmware has to be loaded into the device by the customer) label stickers for the supported master protocols for PROFINET IO, EtherCAT and EtherNet/IP are included in the delivery package, and can be attached to the device by the customer:



PROFINET IO	EtherCAT	EtherNet/IP
		

Table 21: Sticker for NHST-T100-EN

5.4 Device label

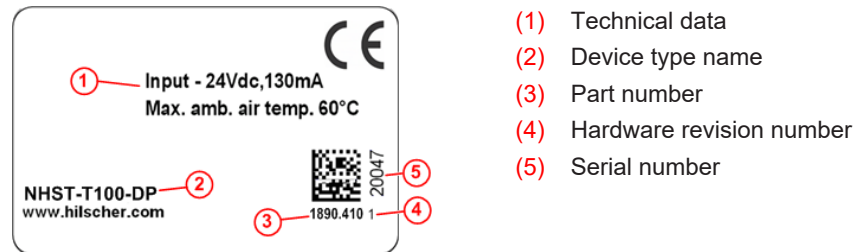

Table 22: Device label (NHST-T100-DP example)

5.5 Power supply connector (X1)

For identification, see position (1) in section *Positions of the LEDs, connectors and control elements* [▶ page 30].

The power supply of the netHOST has to be connected to connector X1. The power supply voltage must be in the range between 18 V and 30 V DC.

Supply voltage	Pin	Signal	Description
	1	0 V / GND	Ground of supply voltage
	2	24 V	+24 V supply voltage
Mini Combicon			

Table 23: Pin assignment Mini Combicon socket 2-pole



Note:

The power supply plug is included in the delivery. If needed as a spare part, the plug can be obtained from RIA CONNECT GmbH in Blumberg, Germany, part number: 31369102-001792.

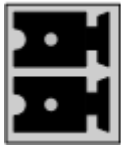
5.6 Ethernet connectors

This section describes the technical details of the LAN and Real-Time Ethernet connectors of the netHOST devices. The details are valid for the LAN interface featured by all netHOST types and for the RTE interface featured only by the netHOST devices for Real-Time Ethernet systems.

For identification of the LAN connector of the **netHOST for Fieldbus systems**, see positions (9) and (12) in section *netHOST for Fieldbus systems* [▶ page 30].

For identification of the LAN connector of the netHOST for Real-Time Ethernet systems, see position (16), for identification of the RTE connectors, see positions (10) and (13) in section *netHOST for Real-Time Ethernet systems* [▶ page 31].

The Ethernet interfaces (LAN and RTE) use RJ45 sockets, with twisted pair cables of category 5 (CAT5) or higher, consisting of four twisted pairs. The maximum baud rate is 100 MBit/s (CAT5).



Note:

The device supports Auto Crossover function. Due to this fact, RX and TX can be switched. The following figure shows the RJ45 standard pinning.

Ethernet	Pin	Signal	Description
	1	TX+	Transmit data positive
	2	TX-	Transmit data negative
	3	RX+	Receive data positive
	4	Term 1	Connected and terminated to PE via RC combination*
	5	Term 1	
	6	RX-	Receive data negative
	7	Term 2	Connected and terminated to PE via RC combination*
	8	Term 2	
			* Bob Smith Termination

Table 24: Ethernet RJ45 pin assignment



If you are using the NHST-T100-EN/ECM for EtherCAT, please note also the user manual *Wiring Instructions EtherCAT*, DOC121104UMxxEN, stored on the netHOST Solutions DVD in the Documentation\english\4.Installation Instructions directory.

5.7 Fieldbus interfaces (X3)

For identification, see position (15) in section *netHOST for Fieldbus systems* [▶ page 30].



Information on fieldbus cabling can be found in the user manual *Wiring Instructions*, DOC120208UMxxEN, stored on the netHOST Solutions DVD in the Documentation\english\4.Installation Instructions directory.

5.7.1 PROFIBUS DP interface (NHST-T100-DP/DPM)

The PROFIBUS DP interface at X3 is a RS-485 interface according to PROFIBUS standard EN 50170.

PROFIBUS	Pin	Signal	Description
<p>9-pole sub-D socket, female</p>	3	Rx/Tx +	Receive- / Transmit data positive
	4	CNTR-P	Control signal for repeater (direction control)
	5	ISO GND	Data ground
	6	VP	Power supply positive 5V for terminating resistor. Maximum current 100 mA.
	8	Rx/Tx -	Receive- / Transmit data negative
	Shield	PE	Metal shell on PE

Table 25: PROFIBUS RS-485 pin assignment

A pull up resistor of 100 kΩ is connected inside the device at “Rx / Tx +”.

A pull down resistor of 100 kΩ is connected inside the device at “Rx / Tx -”.

5.7.2 CANopen interface (NHST-T100-CO/COM)

The CANopen interface at X3 is an ISO 11898 interface according to the CANopen CiA DS 102 standard.

CANopen	Pin	Signal	Description
<p>9-pole sub-D male</p>	2	CAN L	CAN Low bus line
	3	ISO GND	CAN ground
	7	CAN H	CAN High bus line
	1, 4, 5, 6, 8, 9		Important note and strongly recommended: Leave these pins unconnected! Otherwise there is a high risk of a device damage.
	Shield	PE	Metal shell on PE

Table 26: CANopen pin assignment

5.7.3 DeviceNet interface (NHST-T100-DN/DNM)

The pin assignment of the DeviceNet interface at X3 complies with the DeviceNet standard.

DeviceNet	Pin	Signal	Description
 COMBICON socket, female	1	ISO GND	Common ground DeviceNet-power supply.
	2	CAN L	CAN Low signal
	3	Drain	Shield
	4	CAN H	CAN High signal
	5	V+	+24 V DeviceNet-power supply

Table 27: DeviceNet pin assignment

5.8 USB interface (Mini-B USB)

For identification, see section *Positions of the LEDs, connectors and control elements* [▶ page 30].

The USB interface can be used to perform a firmware download/firmware recovery to the netHOST device to its “factory settings” (see section *Using USB to recover firmware* [▶ page 46]).

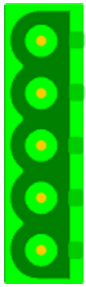
USB Buchse	Pin	Signal	Description
	1	USB_EXT	Power supply USB Bus (+5 V, from externally)
	2	D-	Data -
	3	D+	Data +
	4	ID	
	5	GND	Ground
	Shield	PE	Metal shell to PE

Table 28: Pin assignment Mini-B USB connector (5-pin)

5.9 Schematic diagram of Galvanic isolation

The following schematic diagram illustrates the internal connections between the different connectors X1, X2 and X3 of the netHOST device. This gives you the chance to properly install the device in accordance with the “potential equalization concept” of your plant.

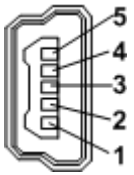

Note:

The PE connection (potential equalization) of the device is done via the DIN rail.

5.9.1 netHOST for Fieldbus systems

Galvanic isolation of the netHOST devices **NHST-T100-DP/DPM**, **NHST-T100-CO/COM** and **NHST-T100-DN/DNM**.

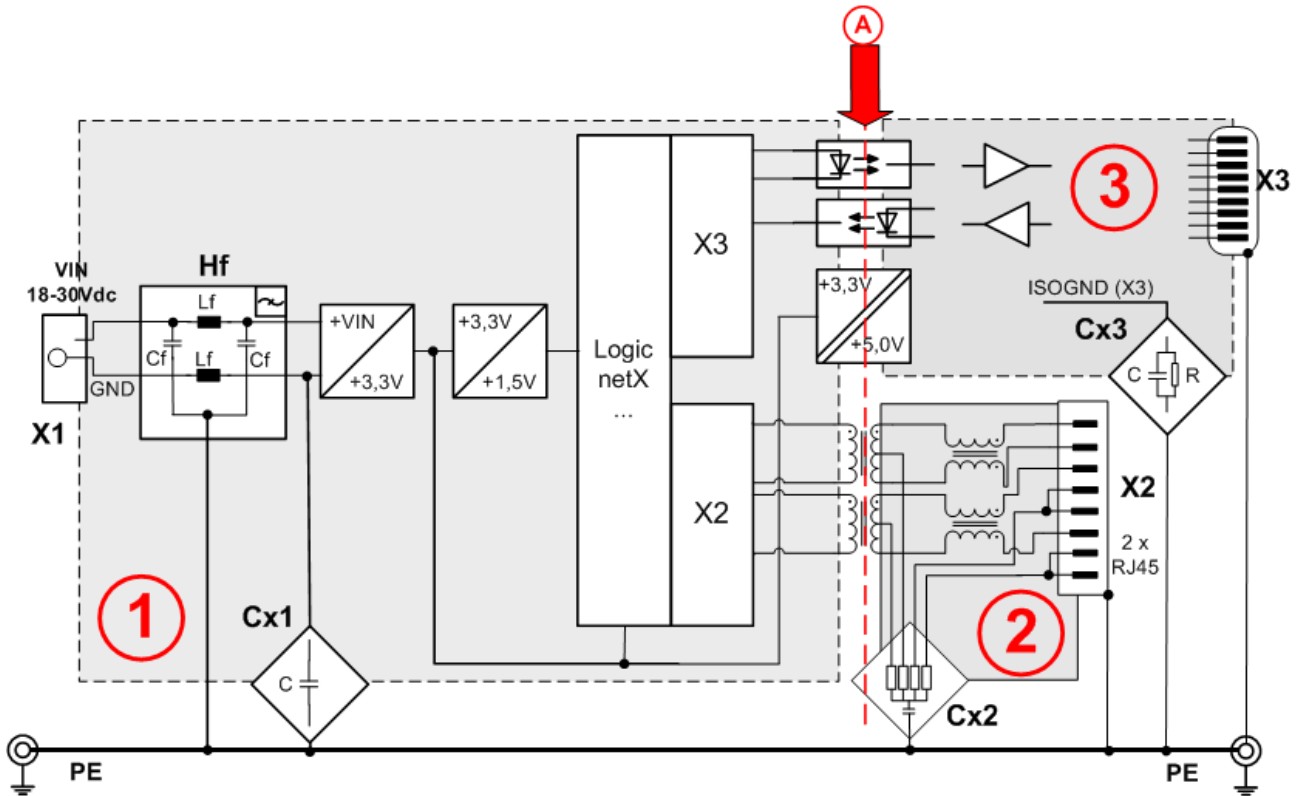

Figure 4: Galvanic isolation of netHOST for Fieldbus systems

The device has three galvanically isolated areas. The isolation to the network connections is indicated by the red arrow (A).

- (1) System area, galvanically coupled with the power supply connection at X1.
- (2) LAN connecting area, 2 * RJ45.
(The figure above shows only one RJ45 socket. The second RJ45 socket is built up identically and connected to the logic at netX X2.)
- (3) Fieldbus connecting area with DSub male / female or Combicon-connector.

The following table shows the characteristics of the galvanic isolation of the different areas and coupling against potential equalization:

Area Connection	Interface	galv. Isolation	Coupling	Coupling against PE potential	Functional earthing to PE
(1) X1	-	no	Cx1 (1)	4 * 10 nF 500V	
			HF (1)	Cf = 10 nF, Lf = 47 µH	
(2) X2	Ethernet	inductive	Cx2 (2)	4 * 75 Ω, 1 nF 2000 V	Directly via the metal connection of RJ 45 sockets
(3) X3	CANopen (NHST-T100-CO)	optically	Cx3 (3)	1 MΩ // 15 nF 1000V	directly
	PROFIBUS (NHST-T100-DP)	inductive	Cx3 (3)	1 MΩ // 2.2 nF 1000 V	directly
	DeviceNet (NHST-T100-DN)	optically	Cx3 (3)	1 MΩ // 15 nF 1000V	1 MΩ // 15 nF 1000V

Table 29: Coupling of netHOST for Fieldbus systems

5.9.2 netHOST for RTE systems

Galvanic isolation of the netHOST devices **NHST-T100-EN**, **NHST-T100-EN/PNM**, **NHST-T100-EN/ECM** and **NHST-T100-EN/EIM**.

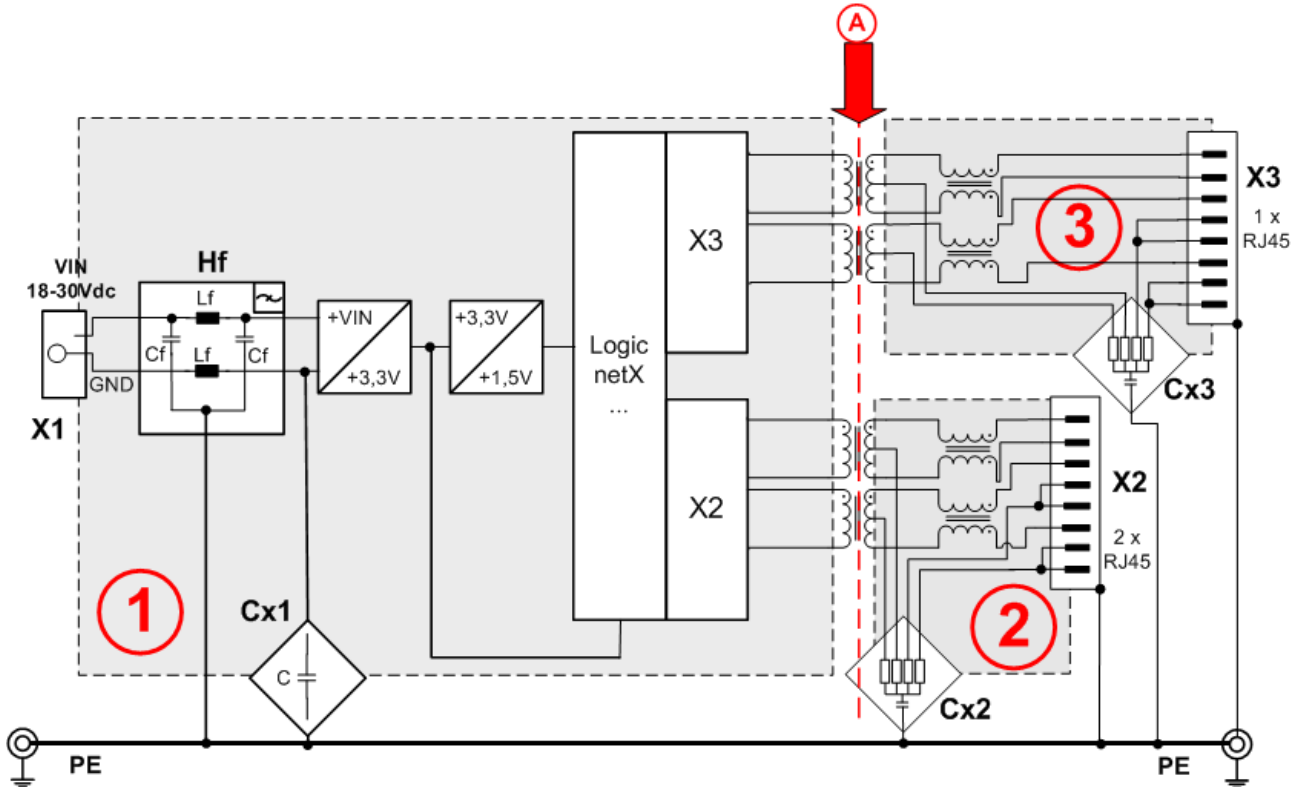

Figure 5: Galvanic isolation of netHOST for RTE systems

The device has three galvanically isolated areas. The isolation to the network connections is indicated by the red arrow (A).

- (1) System area, galvanically coupled with the power supply connection at X1.
- (2) LAN connection area, 2 * RJ45.
(The figure above shows only one RJ45 socket. The second RJ45 socket is built up identically and connected to the logic at netX X2.)
- (3) LAN connection area 1 * RJ45

The following table shows the characteristics of the galvanic isolation of the different areas and coupling against potential equalization:

Area Connection	Interface	galv. Isolation	Coupling	Coupling against PE potential	Functional earthing to PE
(1) X1	-	no	Cx1 (1) HF (1)	4 * 10 nF 500V Cf = 10 nF, Lf = 47 µH	
(2) X2	Real-Time Ethernet	inductive	Cx2 (2)	4 * 75 Ω, 1 nF 2000 V	Directly via the metal connection of RJ 45 sockets
(3) X3	Ethernet	inductive	Cx3 (3)	4 * 75 Ω, 1 nF 2000 V	Directly via the metal connection of RJ 45 socket

Table 30: Coupling of netHOST for RTE systems

6 Mounting and dismounting of netHOST device

6.1 Safety messages

Please observe the following safety messages:

NOTICE**Device Destruction Due to Compensating Currents !**

Please pay attention to the grounding and shielding concept of your plant. The concept should prevent the flowing of compensating currents via signal and power supply lines between the used devices. Otherwise device destruction of the netHOST is possible.

NOTICE**Device Destruction Due to Overheating !**

The air ventilation slots of the netHOST device must not be covered by any objects. Otherwise the device might overheat.

**Important:**

On the top side, the devices should have a minimum distance of 20 mm to the next device.

6.2 Mounting netHOST device onto Top Hat Rail

- The netHOST device is to be mounted onto a horizontally attached top hat rail according to DIN EN 60715.
- The rail has to be connected with the potential equalization conductor (PE).
- The devices can be mounted onto the top hat rail side-by-side without any gap.

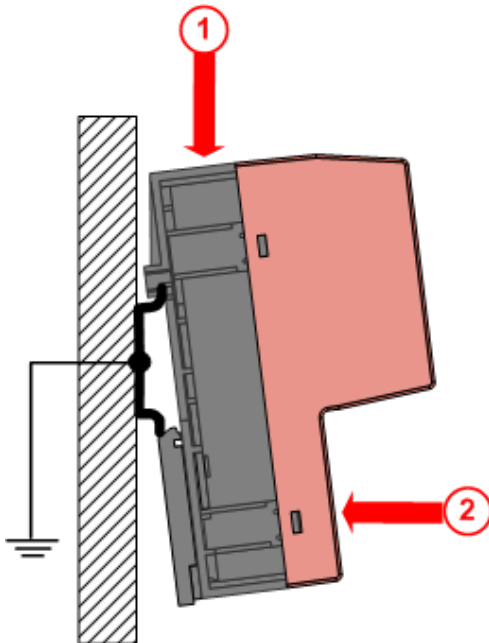

- (1) ➤ Push the device onto the top hat rail from above.
- (2) ➤ Then press the device against the mounting surface.

Table 31: Mounting the netHOST device onto Top Hat Rail

- After mounting, connect the 24 V supply voltage to the device.

NOTICE

Device Destruction by Exceeding the Allowed Supply Voltage!

The supply voltage must not exceed 30 V, otherwise the netHOST device will be damaged.



Note:

Grounding is done via a grounding contact located at the backside of the device, connecting it electrically to the DIN top hat rail.

6.3 Removing netHOST device from the Top Hat Rail

In order to remove the netHOST from the top hat rail, first remove the power supply cable and all data cables from the device.

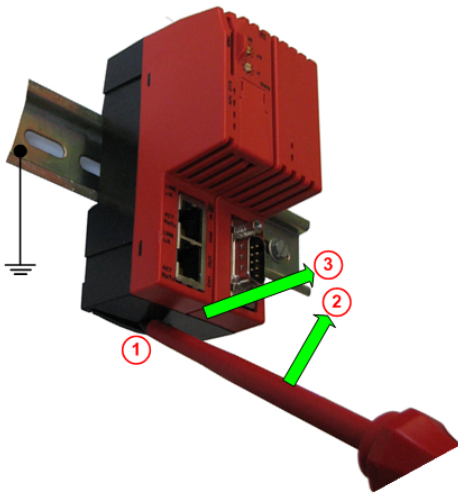

- (1) ➤ To release the device from the top hat rail, put a screw driver to the clip located on the bottom in the middle of the device.
- (2) ➤ To disengage the lock from the top hat rail, press the screw driver upwards.
- (3) ➤ You can then easily pull the device off the top hat rail.

Table 32: Removing the netHOST device from Top Hat Rail

7 Commissioning

7.1 Firmware

With the exception of the **NHST-T100-EN** device (order no.: 1890.800), all netHOST devices are delivered with their firmware already loaded. Thus, you can instantly install, configure and commission the netHOST after delivery. You will find a short summarizing description about configuration in the following section, for detailed instructions and examples see the operating instruction manual *Configuration of LAN controlled master devices – netHOST*.

If you are using the **NHST-T100-EN** device, you first have to download the firmware featuring the Real-Time Ethernet master protocol (PROFINET IO, EtherCAT or EtherNet/IP) to the device with the **SYCON.net** configuration software. Detailed instructions on this can be found in the operating instruction manual *Configuration of LAN controlled master devices – netHOST*. Once you have downloaded the firmware to the **NHST-T100-EN** device, all following configurational steps are same as for the devices with preloaded firmware as described in the operating instruction manual.

7.2 Configuring the netHOST

Assigning IP address with Ethernet Device Configuration Tool

A netHOST device is delivered without its Fieldbus or Real-Time Ethernet configuration and answers at its LAN interface with the default IP address 0.0.0.0.

Before the netHOST device can be configured (in case of the **NHST-T100-EN**, before the firmware can be downloaded to the device), a valid IP address has to be assigned to the netHOST. Use the **Ethernet Device Configuration Tool** for this. The IP address of the device must be in the same sub net as the IP address of the configuration PC, so that it can later be reached for configuration.

Note, that the IP address assigned by the **Ethernet Device Configuration Tool** is kept by the netHOST device only until next power-on cycle or device reset, respectively until a permanent IP address has been configured and downloaded to the device with SYCON.net.

Configuration with SYCON.net

The netHOST device is configured with the Windows configuration software SYCON.net. The configuration is transferred to the netHOST device via LAN connection and TCP/IP protocol (primary network, in case of netHOST devices for Fieldbus systems connected to the X2 interface, in case of netHOST devices for RTE systems to the X3 interface).

SYCON.net allows you to create a configuration “offline”, without any immediate connection to the target device (i. e. the netHOST). Only for the subsequent download of the configuration into the device, you need a physical LAN connection.

The SYCON.net configuration consists of the IP address and the fieldbus or Real-Time Ethernet configuration. The device stores this data remanently, i. e. the data is being kept after power off or device reset.

After updating the firmware of the netHOST device with SYCON.net, the device loses its configuration and its IP address. The device then answers with its default IP address 0.0.0.0 again.



Detailed information about configuration, diagnosis, testing and firmware update can be found in the operating instruction manual *Configuration of LAN controlled master devices – netHOST*, DOC1304020lxxEN, stored on the netHOST Solutions DVD in the Documentation\english\1.Software\SYCON.net directory.

7.3 Start-up behavior

After a return of power or device reset, the start-up behavior of the netHOST device depends on whether at the time of power return an SD memory card is inserted in the device or not.

7.3.1 Start-up without SD memory card

If no card is inserted at the time of power return or reset, the firmware and configuration data (if available) stored permanently in the internal load memory is loaded and started. This can take approximately four seconds, depending on the size of the configuration data.

7.3.2 Start-up with inserted SD memory card

If an SD memory card containing a valid configuration is inserted in the netHOST device at the time of power on, all data stored on the card is copied to the internal load memory of the device.

This data can be:

- firmware
- configuration files
- IP address

All old data stored in the load memory will be erased by this.

With this procedure, you can reset the device to its factory settings or load the desired configuration without having to establish a LAN connection to the SYCON.net configuration software. With the SD card, you can easily “clone” a configuration and transfer it into another device, e. g. into a spare device in case of a defective primary device.

With the SYCON.net configuration software, the data of the internal load memory of the netHOST device can be copied to an empty SD memory card. Note that the SD card must be FAT16 formatted, otherwise it will not be recognized by the device.



Detailed instructions on how to transfer configuration data into another netHOST device by SD memory card can be found in chapter *Using SD Memory Card to Copy Configuration Data to Spare netHOST Devices* in the operating instruction manual *Configuration of LAN controlled master devices – netHOST*, DOC1304020IxxEN.

Resetting the netHOST device to its factory settings by using an SD memory card (e. g. in case of a defective firmware) is described in the subsequent chapter.

8 Firmware recovery

8.1 Overview

If after power-on the SYS LED (for the position of the SYS LED see section *Positions of the LEDs, connectors and control elements* [▶ page 30]) is flashing yellow and green at a rate of 1 Hz, the device is in boot mode. The firmware file of the netHOST device is missing or defective. In this state the device cannot be operated and a new firmware file needs to be loaded into the device either via SD memory card or via USB. When using the SD memory card, all existing configuration or IP address files inside the device will be deleted. The device will thus be reset to its “factory settings”. On the other hand, when using the firmware download function via USB, you can overwrite only the old defective firmware file and keep the configuration files inside the device, thus performing only a “firmware recovery” instead of a “factory reset”. When using USB, you can decide for yourself, whether you also want to delete the configuration files in order to perform a full “factory reset”.

8.2 Using an SD memory card to reset the netHOST to its “factory settings”

The netHOST device can be reset to its factory settings by using the load memory image on an SD memory card. You will find the load memory image on the netHOST Solutions DVD in the Supplements & Examples \netHOST Device Recovery\Recovery via Memory Card directory in the folder of your device type (e. g. NHST-T100-DP_DPM folder for the NHST-T100-DP/DPM device). From there, you can copy the image to the SD memory card, and then use the card to copy it to the netHOST device.

All existing old data (including configuration and IP address) in the internal load memory of the device will thereby be deleted. After recovery by SD card, the device therefore needs a new IP address and a new configuration.



Note:

The SD memory card is not included in the delivery of the netHOST device, but can be obtained from Hilscher. The part number of the card is 1719.003.

Prerequisites

- Empty SD memory card (FAT16 formatted)
- PC with SD card reader device
- netHOST Solutions DVD
- the netHOST device is supplied with voltage

Step-by-step instructions

1. Copy load memory image from DVD to SD card.
 - Insert an empty SD memory card into the SD card reader device of your PC.

- On the netHOST Solutions DVD, open Supplements & Examples \netHOST Device Recovery\Recovery via Memory Card directory.
 - In the directory, open the folder for your type of device, e. g. NHST-T100-DP_DPM, then copy the `STARTUP.INI` file and the `BACKUP` folder (with all its subfolders) to the root directory of the SD memory card.
 - Remove the SD memory card from the SD card reader device.
2. Copy load memory image to netHOST device.
- Disconnect the voltage supply from your netHOST device.
 - Insert the SD card into the card slot of the netHOST device until it engages (see position (2) in section *Positions of the LEDs, connectors and control elements* [▶ page 30]).
 - Reconnect the voltage supply of your netHOST device.
 - ⇒ The device then loads the memory image. While loading the image, the SYS LED quickly alternates between green and yellow for approximately eight seconds, then shows steady yellow for approximately ten seconds, then is switched off for a short while before it finally shows steady green light. The device automatically starts the loaded firmware.
 - Remove the SD memory card from device.
 - ⇒ The netHOST device has been reset to its factory settings. The device now needs an IP address and a configuration.

8.3 Using USB to recover firmware

Via USB, you can reset the netHOST device to its factory settings or, as an alternative, perform a so-called “firmware recovery”, by downloading a new firmware file to the device without thereby deleting any existing configuration files within the device.

For this, you need a USB cable with a Mini USB connector and the Hilscher **ComProX** tool, which is stored on the netHOST Solutions DVD in the `Supplements & Examples\netHOST Device Recovery\Recovery via USB` directory. **ComProX** can be executed directly from DVD, it does not need to be installed on your configuration PC.

Note that for recovery via USB, you need to install the USB driver for the Hilscher netHOST on your configuration PC. This driver allows you to communicate with the netHOST via USB, even if the old firmware within the device is defective or missing altogether.

It is recommended to install the USB driver *before* you connect the netHOST device via USB cable. Use the **setup.exe** driver installation program for this, which is stored on the netHOST Solutions DVD in the `Setups & Drivers\USB Driver` directory.



The installation of the USB driver is described in the user manual *Software Installation netHOST Devices*, DOC130501UMxxEN, which is stored on the netHOST Solutions DVD in the `Documentation\english\4.Installation Instructions` directory.

Note the following concerning recovery via USB:

Although any old firmware file that may have existed in the netHOST device will be overwritten by downloading the new firmware file (recognizable by the `.NXF` file name extension), all other files stored in the internal load memory of the device remain untouched. This means that any existing configuration (`CONFIG.NXD`) or IP address (`NWID.NXD`) file in the device can be preserved for further use, if needed. However, if you want a complete reset of your device via USB (a complete reset to “factory setting” means that only “fresh” firmware is present in the device), you can delete the configuration and the address files separately in the **Explorer** of the **ComProX** tool.

Prerequisites

- The USB driver for Hilscher netHOST has been installed on the configuration PC (the driver is included in the USB driver installation program stored on the netHOST Solutions DVD).
- The configuration PC has been connected to the netHOST device via USB cable.
- You have access to the netHOST Solutions DVD.
- The netHOST device is supplied with voltage.

Step-by-step instructions

1. Open ComProX.
 - On the netHOST Solutions DVD, open Supplements & Examples \netHOST Device Recovery\Recovery via USB directory.
 - Double-click **comproX.exe** file.
 - The **ComProX** tool opens:

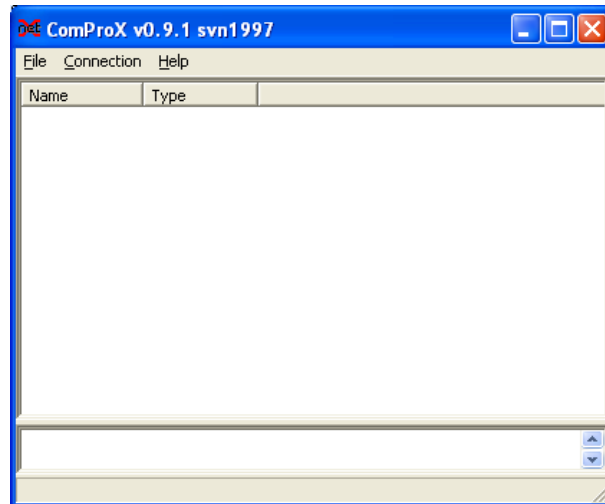

Figure 6: ComProX start screen

2. Connect to netHOST device.
 - In the menu, choose **Connection > Open**.
 - After the Windows USB/COM ports have been scanned, the connection selection dialog opens:

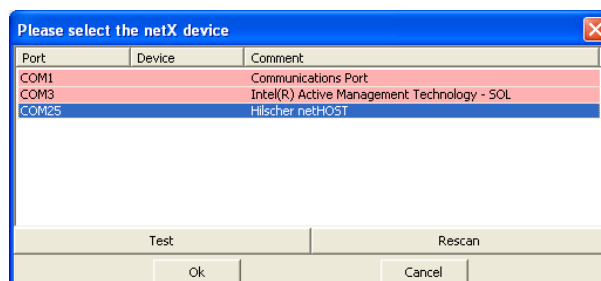

Figure 7: ComProX Connection dialog

- Select **Hilscher netHOST** entry, then click **OK**.
 - The connection dialog closes and you are back in start screen of ComProX.
3. Download firmware file.
 - In the menu, choose **Connection > File Explorer**.

➤ The **Explorer** window opens:

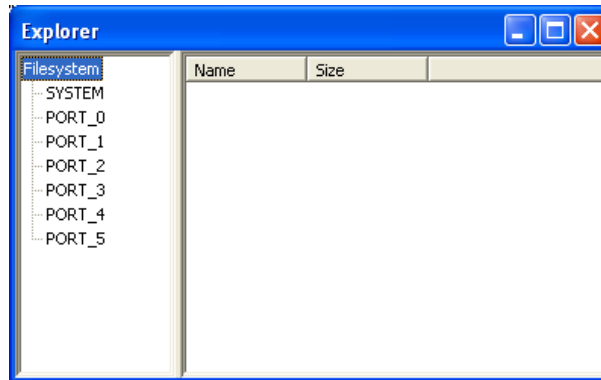

Figure 8: ComProX File Explorer

- Under **Filesystem**, select **PORT_0**.
- The content of PORT_0 is displayed. This, most likely, will be the old firmware file, which you want to overwrite. If you have already downloaded a configuration to the netHOST, the IP address configuration file (**NWID.NXD**) is also displayed here.
- In the right part of the **Explorer** window, right-click to open the context menu, then choose **Download**.

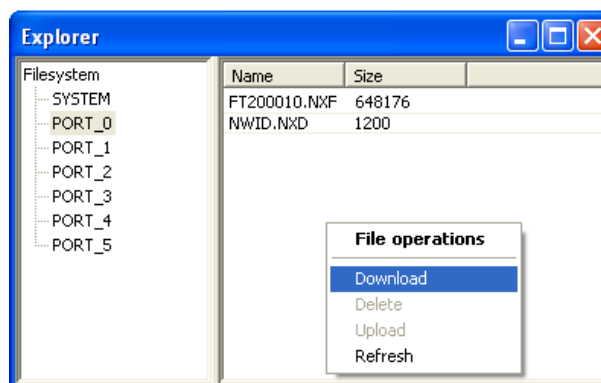

Figure 9: ComProX Download

➤ The **Choose a file** dialog opens:

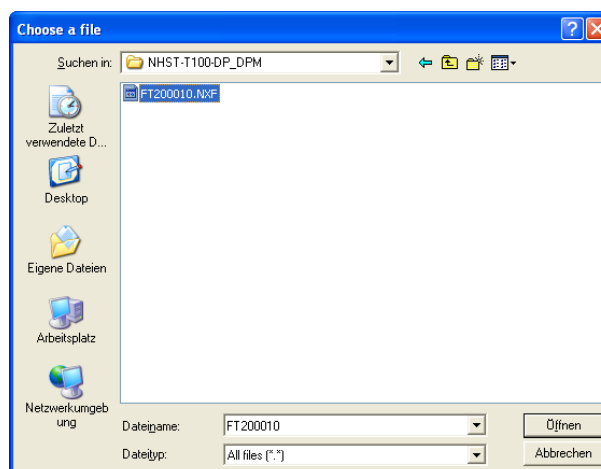

Figure 10: Choose a file dialog in ComProX

- Open the folder for your device and select the firmware file you want to download to your device (firmware files can be recognized by the file name extension .NXF).
 - Click **Open**.
 - ⇒ The firmware file is being downloaded to the netHOST device. The old firmware file is being overwritten. This can take a few seconds.
4. Check download.
- In the right part of the **Explorer** window, right-click to open the context menu, then choose **Refresh**.
 - Wait for a few seconds.
 - ⇒ If the download has been successful, the downloaded firmware file is displayed in **Port 0**:

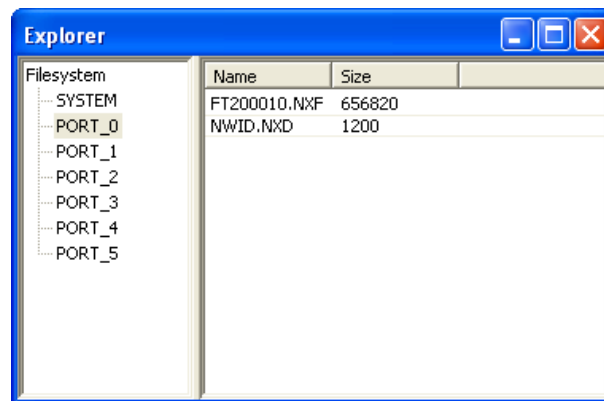

Figure 11: Downloaded firmware in Explorer



Note:

If there is an IP address file (**NWID.NXD**) present in **Port_0** and configuration files (**CONFIG.NXD**) in **Port_1**, and you do not want to use these configuration files any longer, you can delete them in order to completely reset the device to its “factory settings”. For this, select the configuration file in the **Explorer**, then choose **Delete** command from the context menu.

5. Exit ComProX.
- Close the **Explorer** window.
 - In the menu of ComProX, choose **Connection > Close** to close the connection to the device.
 - Close **ComProX**.
6. Restart netHOST device.
- Disconnect the voltage supply from the netHOST device, then reconnect it.
 - ⇒ After restart, the SYS LED shows steady green light. The state of the APL LED depends on whether a valid configuration is still present in the device. If this is not the case, the APL LED is blinking red.

9 Troubleshooting

There are two steps of error diagnosis:

- the initial approximate diagnosis by checking the LEDs of the device,
- the comprehensive diagnosis with the SYCON.net configuration and diagnosis software via LAN connection.

The following overview describes the error conditions that may be detected by checking the LEDs (for identification of the LEDs, please refer to section *Positions of the LEDs, connectors and control elements* [▶ page 30]).



For information on how to diagnose the netHOST device with SYCON.net, see Operating Instruction Manual *Configuration of LAN controlled master devices – netHOST*, DOC130402OixxEN, stored on the netHOST Solutions DVD in the `Documentation\english\1.Software\SYCON.net` directory.







LED	LED state	Cause/remedy
All	No LED is on	The device is not powered or the device is defective and needs replacement.
SYS RTE devices: position (4) Fieldbus devices: position (5)	SYS LED flashes  yellow/green at 1 Hz	After a power cycle the device has not found a valid firmware and remains in boot loader mode. The firmware of the device has to be “recovered”. See chapter <i>Firmware-Recovery</i> [▶ page 44]. If recovery fails, the load memory of the device might be defective.
SYS RTE devices: position (4) Fieldbus devices: position (5)	SYS LED flashes  yellow	The device could not be initialized. No boot loader was found in the load memory. The load memory of the device might be defective or a USB cable, which has pin 4 connected with ground, might be attached to the device. This prevents the device from starting.
SYS RTE devices: position (4) Fieldbus devices: position (5)	SYS LED shows static  yellow	The hardware of the device is defective and needs replacement.
SYS RTE devices: position (4) Fieldbus devices: position (5) APL RTE devices: position (5) Fieldbus devices: position (6)	SYS LED shows static  green and APL LED flashes  red or shows static  red.	The device is well initialized. Further diagnosis is possible with the APL LED. See section <i>LED APL</i> [▶ page 52].
APL RTE devices: position (5) Fieldbus devices: position (6)	APL LED flashes  green.	The communication at port X2 or/and port X3 is not in data exchange mode. See also section <i>LED APL</i> [▶ page 52].

Table 33: netHOST troubleshooting by LED

For protocol-specific error diagnostics by LED, see section *LEDs of the Fieldbus and Real-Time Ethernet systems* [▶ page 53].

10 LEDs

This chapter describes the meaning of the LEDs of the netHOST device. For identification of the LEDs on the device, please refer to section *Positions of the LEDs, connectors and control elements* [▶ page 30].

10.1 SYS LED

This LED indicates basic operating states which are independent of the configuration of the device.











LED	Color	State	Meaning
SYS RTE devices: position (4) Fieldbus devices: position (5)	Duo LED yellow/green		
	 (green)	On	Operating System running. For further diagnosis, see APL LED.
	 (yellow)	On	The hardware of the device is defective and needs replacement.
	 (yellow)	Flashing	The device could not be initialized. No boot loader was found in the load memory. The load memory of the device might be defective or a USB cable, which has pin 4 connected with ground, might be attached to the device. This prevents the device from starting.
	 (yellow/green)	Flashing yellow/green 1 Hz	Error state! Boot loader active. Firmware file is missing or defective. The device needs to be recovered by SD memory card or via USB. See chapter <i>Firmware recovery</i> [▶ page 44].
	 (yellow/green)	Flashing yellow/green 16 Hz	Data is being copied from the SD memory card into the internal load memory.
	 (off)	Off	Power supply for the device is missing or hardware is defective.

Table 34: System LED

10.2 APL LED

This LED indicates the communication state of the primary network (Ethernet LAN) and the secondary network (Fieldbus or Real-Time Ethernet), as well as the state of the configuration of the netHOST device.

LED	Color	State	Meaning
APL	Duo LED red/green		
RTE devices: position (5) Fieldbus devices: position (6)	 (green)	On	The Ethernet cable of the primary network is plugged in at the LAN interface. The netHOST device communicates via secondary network (Fieldbus or Real-Time Ethernet) and exchanges payload data. The netHOST function is executed without error. Note: This does not indicate a connection to a host application.
	 (green)	Blinking with 2 s off, 0.5 s on	netHOST is initialized, a valid configuration is present in the device. The netHOST communicates via secondary network, but the LAN interface at the primary network shows no activity. The Ethernet cable has been removed from the LAN interface. Reconnect the cable.
	 (green)	Blinking with 2 s off, 0.5 s on, 0.5 s off, 0.5 s on	netHOST is initialized, a valid configuration is present in the device. Communication at the secondary network (Fieldbus or Real-Time Ethernet) is not in payload data exchange. <ul style="list-style-type: none"> In the netHOST configuration, the starting mode for communication at the interface of the secondary network is set to “controlled by the host application”, which is the default setting. Please check this setting in the configuration software. Check also, whether or not the start command from the host application has already been issued. netHOST as Fieldbus or Real-Time Ethernet master after start command: The netHOST has no payload data connection to any of the configured slaves. The configuration of the netHOST might not match the configuration of the slaves or the fieldbus or RTE cable is not connected. Use the SYCON.net configuration software for diagnosis.
	 (red)	Blinking with 2 s off, 0.5 s on	netHOST is initialized, but the configuration of the primary network (LAN) does not allow communication. <ul style="list-style-type: none"> DHCP mode was configured for the LAN network, but the device has not yet received an IP address from the DHCP server. Check the DHCP server and your configuration. An IP address has been configured, but it conflicts with another IP address already used in the LAN network. Configuration is missing in the netHOST device. Use the SYCON.net configuration software to download the configuration. LAN configuration has an error.



LED	Color	State	Meaning
APL RTE devices: position (5) Fieldbus devices: position (6)	 (red)	Blinking with 2 s off, 0.5 s on, 0.5 s off, 0.5 s on	netHOST is initialized, but the configuration of the secondary network protocol (Fieldbus or Real-Time Ethernet) does not allow communication. Use the SYCON.net configuration software to download the configuration again. <ul style="list-style-type: none"> • A watchdog timeout error has occurred while the watchdog for host application was active. The Fieldbus or RTE network has been set to operating mode “stop”. Check the LAN connection to the host application. The connection to the host application has to be re-established. • The configuration of the Fieldbus/RTE network has an error. • The configuration of the Fieldbus/RTE network is not complete. • The configuration of the Fieldbus/RTE network is missing.
	 (red)	On	netHOST has detected one of the following errors during the initialization: <ul style="list-style-type: none"> • Missing configuration • Error in configuration • Internal sequence error

Table 35: APL LED

10.3 LEDs of the Fieldbus and Real-Time Ethernet systems

10.3.1 LED PROFIBUS DP Master (NHST-T100-DP/DPM)

The subsequent table describes the meaning of the COM LED of the NHST-T100-DP/DPM netHOST device.







LED	Color	State	Meaning
COM Position in the device drawing: (14)	Duo LED red/green		
	 (green)	On	Communication to all Slaves is established.
	 (green)	Blinking (5 Hz)	PROFIBUS is configured, but the bus communication is not yet released from the application.
	 (green)	Flashing, acyclic	No configuration or faulty configuration
	 (red)	Blinking (5 Hz)	Communication to at least one Slave is disconnected.
	 (red)	On	Communication to all Slaves is disconnected or another serious error has occurred. Redundant Mode: The active Master was not found.
 (off)	Off	Device is not switched on or supply voltage is missing.	

Table 36: LED states for the PROFIBUS DP Master protocol

LEDs states	Definition
Blinking (5 Hz)	The indicator turns on and off with a frequency of 5 Hz: “on” for 100 ms, followed by “off” for 100 ms.
Flashing, acyclic	The indicator turns on and off in irregular intervals.

Table 37: LED state definitions for the PROFIBUS DP Master protocol

10.3.2 LED CANopen Master (NHST-T100-CO/COM)

The subsequent table describes the meaning of the CAN LED of the NHST-T100-CO/COM netHOST device:







LED	Color	State	Meaning
CAN Position in the device drawing: (14)	Duo LED red/green		
	 (green)	On	OPERATIONAL: The device is in the OPERATIONAL state.
	 (green)	Blinking (2.5 Hz)	PREOPERATIONAL: The device is in the PREOPERATIONAL state.
	 (green)	Single flash	STOPPED: The device is in STOPPED state.
	 (red)	Single flash	Warning limit reached: At least one of the error counters of the CAN controller has reached or exceeded the warning level (too many error frames).
	 (red)	Double flash	Error control event: A guard event (NMT Slave or NMT Master) or a heartbeat event (Heartbeat consumer) has occurred.
	 (red)	On	Bus off: The CAN controller is in bus OFF state.
 (off)	Off	RESET: The device is executing a reset or the device has no configuration.	

Table 38: LED states for the CANopen Master protocol

LED states	Definition
Blinking (2.5 Hz)	The indicator turns on and off with a frequency of 2.5 Hz: "on" for 200 ms, followed by "off" for 200 ms.
Single flash	The indicator shows one short flash (200 ms) followed by a long "off" phase (1,000 ms).
Double flash	The indicator shows a sequence of two short flashes (each 200 ms), separated by a short "off" phase (200 ms). The sequence is finished by a long "off" phase (1,000 ms).

Table 39: LED state definitions for the CANopen Master protocol

10.3.3 LED DeviceNet Master (NHST-T100-DN/DNM)

The subsequent table describes the meaning of the MNS LED of the NHST-T100-DN/DNM netHOST device:









LED	Color	State	Meaning
MNS Position in the device drawing: (14)	Duo LED red/green		
	 (green)	On	Device operational AND on-line, connected Device is online and has established all connections with all Slaves.
	 (green)	Flashing (1 Hz)	Device operational AND on-line Device is online and has established no connection in the established state. - Configuration missing, incomplete or incorrect.
	   (green/red/off)	Flashing green/red/off	Self-test: The device is performing its power-up testing. The indicator turns green for approximately 250 ms, turns red for approximately 250 ms, and then turns off.
	 (red)	Flashing (1 Hz)	Minor fault and/or connection time-out Device is online and has established one or more connections in the established state. It has data exchange with at least one of the configured slaves. Minor or recoverable fault: No data exchange with one of the configured Slaves. One or more Slaves are not connected. Connection timeout. No network power present.
	 (red)	On	Critical fault or critical link failure Critical connection failure; device has detected a network error: duplicate MAC-ID or severe error in CAN network (CAN-bus off).
	 (off)	Off	Device is not powered - The device may not be powered. Device is not on-line and/or no network power - The device has not yet completed the Dup_MAC_ID test. - The device is powered, but the network power is missing.

Table 40: LED states for the DeviceNet Master protocol

LED state	Definition
Flashing (1 Hz)	The indicator turns on and off with a frequency of 1 Hz: "on" for 500 ms, followed by "off" for 500 ms.
Flashing green/red/off	The indicator turns on green on for 250 ms, then red on for 250 ms, then off.

Table 41: LED state definitions for the DeviceNet Master protocol

10.3.4 LEDs PROFINET IO Controller

The subsequent table describes the meaning of the PROFINET IO Controller LEDs of the NHST-T100-EN/PNM, respectively of the NHST-T100-EN with loaded PROFINET IO Controller firmware.

LED	Color	State	Meaning
SF (System Failure) Position in the device drawing: (7)	Duo LED red/green		
	● (off)	Off	No error
	☀ (red)	Flashing (1 Hz, 3 s)	DCP signal service is initiated via the bus.
	☀ (red)	Flashing (2 Hz)	System error: Invalid configuration, Watchdog error or internal error
BF (Bus Failure) Position in the device drawing: (8)	Duo LED red/green		
	● (off)	Off	No error
	☀ (red)	Flashing (2 Hz)	Configuration fault: Not all configured IO-Devices are connected.
	● (red)	On (together with SF "red ON")	No valid Master license
LINK Ch0 (9), Ch1 (12)	LED green		
	● (green)	On	The device is linked to the Ethernet.
	● (off)	Off	The device has no link to the Ethernet.
RX/TX Ch0 (11), Ch1 (14)	LED yellow		
	☀ (yellow)	Flickering (load dependent)	The device sends/receives Ethernet frames.
	● (off)	Off	The device does not send/receive Ethernet frames.

Table 42: LED states for the PROFINET IO-Controller protocol

LED state	Definition
Flashing (1 Hz, 3 s)	The indicator turns on and off for 3 seconds with a frequency of 1 Hz: "on" for 500 ms, followed by "off" for 500 ms.
Flashing (2 Hz)	The indicator turns on and off with a frequency of 2 Hz: "on" for 250 ms, followed by "off" for 250 ms.
Flickering (load dependant)	The indicator turns on and off with a frequency of approximately 10 Hz to indicate high Ethernet activity: "on" for approximately 50 ms, followed by "off" for 50 ms. The indicator turns on and off in irregular intervals to indicate low Ethernet activity.

Table 43: LED state definitions for the PROFINET IO-Controller protocol

10.3.5 LEDs EtherCAT Master

The subsequent table describes the meaning of the EtherCAT Master LEDs of the NHST-T100-EN/ECM, respectively of the NHST-T100-EN with loaded EtherCAT Master firmware.

LED	Color	State	Meaning
RUN Position in the device drawing: (7)	Duo LED red/green		
	● (off)	Off	INIT: The device is in INIT state.
	☀ (green)	Blinking (2.5 Hz)	PRE-OPERATIONAL: The device is in PRE-OPERATIONAL state.
	☀ (green)	Flickering (10 Hz)	The device is not configured.
	☀ (green)	Single flash	SAFE-OPERATIONAL: The device is in SAFE-OPERATIONAL state.
	● (green)	On	OPERATIONAL: The device is in the OPERATIONAL state.
ERR Position in the device drawing: (8)	Duo LED red/green		
	● (off)	Off	Master has no errors
	☀ (red)	Single flash	Bus Sync error threshold
	☀ (red)	Double flash	Internal Stop of the bus cycle
	☀ (red)	Triple Flash	DPM watchdog has expired.
	☀ (red)	Quadruple Flash	No Master license present in the device.
	☀ (red)	Blinking (2.5 Hz)	Error in the configuration database.
	☀ (red)	Single Flickering	Channel Init was executed at the Master. Transient state that may not be visible.
	☀ (red)	Double Flickering	Slave is missing Unconfigured slave No matching mandatory slave list No bus connected
☀ (red)	Flickering (10 Hz)	Boot-up was stopped due to an error.	
LINK Ch0 (9)	LED green		
	● (green)	On	Link: The device is linked to the Ethernet, but does not send/receive Ethernet frames.
	☀ (green)	Flickering (load dependent)	Activity: The device is linked to the Ethernet and sends/receives Ethernet frames.
	● (off)	Off	The device has no link to the Ethernet.
ACT Ch0 (11)	LED yellow		
	● (off)	Off	This LED is not used.

Table 44: LED states for the EtherCAT Master(V4) protocol

LED state	Definition
Single flash	The indicator shows one short flash (200 ms) followed by a long "off" phase (1,000 ms).
Double flash	The indicator shows a sequence of two short flashes (each 200 ms), separated by a short off phase (200 ms). The sequence is finished by a long off phase (1,000 ms).
Triple Flash	The indicator shows a sequence of three short flashes (each 200 ms), separated by a short off phase (200 ms). The sequence is finished by a long off phase (1,000 ms).
Quadruple Flash	The indicator shows a sequence of four short flashes (each 200 ms), separated by a short off phase (200 ms). The sequence is finished by a long off phase (1,000 ms).

LED state	Definition
Blinking (2.5 Hz)	The indicator turns on and off with a frequency of 2.5 Hz: "on" for 200 ms, followed by "off" for 200 ms.
Single Flickering	The indicator is switched on and off once: "on" for 50 ms, followed by "off" for 500 ms.
Double Flickering	The indicator is switched on and off and on once: "on" / "off" / "on" each for approximately 50 ms, followed by "off" for 500 ms.
Flickering (10 Hz)	The indicator turns on and off with a frequency of 10 Hz: "on" for 50 ms, followed by "off" for 50 ms.
Flickering (load dependent)	The indicator turns on and off with a frequency of approximately 10 Hz to indicate high Ethernet activity: on for approximately 50 ms, followed by off for 50 ms. The indicator turns on and off in irregular intervals to indicate low Ethernet activity.

Table 45: LED state definitions for the EtherCAT Master(V4) protocol

10.3.6 LEDs EtherNet/IP Scanner

The subsequent table describes the meaning of the EtherNet/IP Scanner LEDs of the NHST-T100-EN/EIM, respectively of the NHST-T100-EN with loaded EtherNet/IP Scanner firmware.





















LED	Color	State	Meaning
MS (module status)	Duo LED red/green		
Position in the device drawing: (7)	 (green)	On	Device operational: The device is operating correctly.
	 (green)	Flashing (1 Hz)	Standby: The device has not been configured.
	   (green/red/green)	Flashing green/red/green	Self-test: The device is performing its power-up testing. The module status indicator test sequence occurs before the network status indicator test sequence, according to the following sequence: <ul style="list-style-type: none"> • Network status LED off. • Module status LED turns green for approximately 250 ms, turns red for approximately 250 ms, and again turns green (and holds that state until the power-up test has completed). • Network status LED turns green for approximately 250 ms, turns red for approximately 250 ms, and then turns off (and holds that state until the power-up test has completed).
	 (red)	Flashing (1 Hz)	Major recoverable fault: The device has detected a major recoverable fault. E.g., an incorrect or inconsistent configuration can be considered a major recoverable fault.
	 (red)	On	Major unrecoverable fault: The device has detected a major unrecoverable fault.
	 (off)	(Off)	No power: The device is powered off.
NS (Network status)	Duo LED red/green		
Position in the device drawing: (8)	 (green)	On	Connected: An IP address is configured, at least one CIP connection (any transport class) is established, and an Exclusive Owner connection has not timed out.
	 (green)	Flashing (1 Hz)	No connections: An IP address is configured, but no CIP connections are established, and an Exclusive Owner connection has not timed out.
	   (green/red/off)	Flashing green/red/off	Self-test: The device is performing its power-up testing. Refer to description for module status LED self-test.
	 (red)	Flashing (1 Hz)	Connection timeout: An IP address is configured, and an Exclusive Owner connection for which this device is the target has timed out. The network status indicator returns to steady green only when all timed out Exclusive Owner connections are reestablished.
	 (red)	On	Duplicate IP: The device has detected that its IP address is already in use.
	 (off)	Off	Not powered, no IP address: The device does not have an IP address (or is powered off).
LINK	LED green		
Ch0: (9), Ch1: (12)	 (green)	On	The device is linked to the Ethernet.
	 (off)	Off	The device has no link to the Ethernet.
ACT	LED yellow		
Ch0: (11), Ch1: (14)	 (yellow)	Flickering (load dependent)	The device sends/receives Ethernet frames.
	 (off)	Off	The device does not send/receive Ethernet frames.

Table 46: LED states for the EtherNet/IP Scanner protocol

LED state	Definition
Flashing (1 Hz)	The indicator turns on and off with a frequency of 1 Hz: "on" for 500 ms, followed by "off" for 500 ms.
Flashing green/red/green	The MS LED indicator turns on green on for 250 ms, then red on for 250 ms, then green on (until the test is completed).
Flashing green/red/off	The NS LED indicator turns on green on for 250 ms, then red on for 250 ms, then off (until the test is completed).
Flickering (load dependent)	The indicator turns on and off with a frequency of approximately 10 Hz to indicate high Ethernet activity: on for approximately 50 ms, followed by off for 50 ms. The indicator turns on and off in irregular intervals to indicate low Ethernet activity.

Table 47: LED state definitions for the EtherNet/IP Scanner protocol

11 Technical data

11.1 Technical data of the netHOST devices

11.1.1 netHOST for Fieldbus systems

NHST-T100-DP/CO/DN	Parameter	Value
Communication controller	Type	netX 100
Memory	RAM	8 MB SDRAM
	FLASH	4 MB serial Flash
	SD memory card (optional)	max. 2 GByte Do not use SDHC- or SDXC- card types
USB Interface	USB Socket	Mini-USB, 5-pin
Display	LEDs	SYS system status netHOST APL application status netHOST LINK Link (LAN interface) ACT Activity (LAN interface) Fieldbus communication status: NHST-T100-DP/DPM: COM NHST-T100-CO/COM: CAN NHST-T100-DN/DNM: MNS
Power supply	Voltage	24 V ± 6 V DC with reverse voltage protection
	Current at 24 V (typically)	130 mA
	Power consumption	3.2 W
	Connector	Mini-COMBICON, 2-pin
	Power supply	For UL compliant usage: Device shall be supplied by an isolated voltage source.
Environmental conditions	Temperature range	0 ... + 60 °C
	Humidity	No condensation permitted
	Environment	For UL compliant usage: Device must be used in a pollution degree 2 environment.
	Altitude	0 m ... 2000 m
Device	Dimensions (L x W x H)	100 x 52 x 70 mm (without connector)
	Weight	appr. 150 g
	Mounting	on DIN rail EN 60715
	Protection class	IP 20
	RoHS	Yes
Conformance with EMC directives	CE Sign	Yes
	UKCA Sign	Yes
	Emission	EN 55011 / BS EN 55011
	Immunity	EN 61131-2 / BS EN 61131-2
Configuration	Software	SYCON.net Ethernet Device Configuration Tool

Table 48: Technical data netHOST for Fieldbus systems (Part 1)

NHST-T100-DP/CO/DN	Parameter	Value
Ethernet Interface (X2)	Transmission rate	100 MBit/s 10 MBit/s
	Interface type	100 BASE-TX, isolated
	Half duplex/Full duplex	supported (at 100 MBit/s)
	Auto-Negotiation	supported
	Auto-Crossover	supported
	Connector	2 * RJ45
PROFIBUS DP Interface (X3) NHST-T100-DP	Transmission rate	9.6 kBit/s, 19.2 kBit/s, 31.25 kBit/s, 45.45 kBit/s, 93.75 kBit/s, 187.5 kBit/s, 500 kBit/s, 1.5 MBit/s, 3 MBit/s, 6 MBit/s, 12 MBit/s
	Interface type	RS 485, optically isolated
	Connector	SubD female, 9-pin
CANopen Interface (X3) NHST-T100-CO	Transmission rate	10 kBit/s, 20 kBit/s, 50 kBit/s, 100 kBit/s, 125 kBit/s, 250 kBit/s, 500 kBit/s, 800 kBit/s, 1 MBit/s
	Interface type	ISO 11898, optically isolated
	Connector	SubD male, 9-pin
DeviceNet Interface (X3) NHST-T100-DN	Transmission rate	125 kBit/s, 250 kBit/s, 500 kBit/s
	Interface type	ISO 11898, optically isolated
	Connector	COMBICON, 5-pin

Table 49: Technical data netHOST for Fieldbus systems (Part 2)

11.1.2 netHOST for Real-Time Ethernet systems

NHST-T100-EN/PNM/ECM/EIM	Parameter	Value
Communication controller	Type	netX 100
Memory	RAM	8 MB SDRAM
	FLASH	4 MB serial Flash
	SD memory card (optional)	max. 2 GByte Do not use SDHC- or SDXC- card types
USB Interface	USB Socket	Mini-USB, 5-pin
Display	LEDs	SYS system status netHOST APL application status netHOST LINK Link (LAN and RTE interface) ACT Activity (LAN and RTE interface) Protocol specific LEDs: PROFINET IO Controller: SF, BF EtherCAT Master: RUN, ERR Ethernet/IP Scanner: MS, NS
Power supply	Voltage	24 V ± 6 V DC with reverse voltage protection
	Current at 24 V (typically)	130 mA
	Power consumption	3.2 W
	Connector	Mini-COMBICON, 2-pin
	Power supply	For UL compliant usage: Device shall be supplied by an isolated voltage source.
Environmental conditions	Temperature range	0 ... + 60 °C
	Humidity	No condensation permitted
	Environment	For UL compliant usage: Device must be used in a pollution degree 2 environment.
	Altitude	0 m ... 2000 m
Device	Dimensions (L x W x H)	100 x 52 x 70 mm (without connector)
	Weight	appr. 150 g
	Mounting	on DIN rail EN 60715
	Protection class	IP 20
	RoHS	Yes
Conformance with EMC directives	CE Sign	Yes
	UKCA Sign	Yes
	Emission	EN 55011 / BS EN 55011
	Immunity	EN 61131-2 / BS EN 61131-2
Configuration	Software	SYCON.net Ethernet Device Configuration Tool
Ethernet Interfaces (RTE at X2 and LAN at X3)	Transmission rate	100 MBit/s 10 MBit/s
	Interface type	100 BASE-TX, isolated
	Half duplex/Full duplex	supported (at 100 MBit/s)
	Auto-Negotiation	supported
	Auto-Crossover	supported
	Connector	X2 (RTE interface): 2 x RJ45 X3 (LAN interface): 1 x RJ45

Table 50: Technical data netHOST for Real-Time Ethernet systems

11.2 Technical data of the protocols

11.2.1 PROFIBUS DP Master (NHST-T100-DP/DPM)

Parameter	Description
Maximum number of PROFIBUS DP slaves	125 (DPV0/DPV1)
Maximum number of total cyclic input data	5712 bytes
Maximum number of total cyclic output data	5760 bytes
Maximum number of cyclic input data	244 bytes per slave
Maximum number of cyclic output data	244 bytes per slave
Configuration data	Max. 244 bytes per slave
Parameterization data per slave	7 bytes standard parameter per slave Max. 237 bytes application specific parameters per slave
Acyclic communication	DPV1 class 1 read, write DPV1 class 1 alarm DPV1 class 2 initiate, read, write, data transport, abort
Maximum number of acyclic read/write	240 bytes per slave and telegram
Functions	Configuration in Run (CiR), requires host application program support Timestamp (Master functionality)
Redundancy	Supported, requires host application program support
Baud rate	9,6 kBits/s, 19,2 kBits/s, 31,25 kBits/s, 45,45 kBits/s, 93,75 kBits/s, 187,5 kBits/s, 500 kBits/s, 1, 5 MBits/s, 3 MBits/s, 6 MBits/s, 12 MBit/s Auto baud rate detection is not supported
Data transport layer	PROFIBUS FDL
Limitations	DPV2 isochronous mode and slave slave communication are not supported. The redundancy function cannot be used, if the master is configured by the host application program by packets.
Reference to firmware/stack version	2.6.x.x

Table 51: Technical data PROFIBUS DP Master protocol

11.2.2 CANopen Master (NHST-T100-CO/COM)

Parameter	Description
Maximum number of CANopen nodes	126
Maximum number of cyclic input data	3584 bytes
Maximum number of cyclic output data	3584 bytes
Maximum number of receive PDOs	512
Maximum number of transmit PDOs	512
Exchange of process data	Via PDO transfer: - synchronized, - remotely requested and - event driven (change of date)
Acyclic communication	SDO Upload/Download, max. 512 bytes per request
Functions	Emergency message (consumer and producer) Node guarding / life guarding, heartbeat PDO mapping NMT Master SYNC protocol (producer) Simple boot-up process, reading object 1000H for identification
Baud rates	10 kBits/s, 20 kBits/s, 50 kBits/s, 100 kBits/s, 125 kBits/s, 250 kBits/s, 500 kBits/s, 800 kBits/s, 1 MBits/s
CAN layer 2 access	Send/receive via API supported (11 bit/29 bit)
Data transport layer	CAN Frames
CAN Frame type for CANopen	11 Bit
Reference to version	V2.11.x.x

Table 52: Technical data CANopen Master protocol

11.2.3 DeviceNet Master (NHST-T100-DN/DNM)

Parameter	Description
Maximum number of DeviceNet slaves	63
Maximum number of total cyclic input data	3584 bytes
Maximum number of total cyclic output data	3584 bytes
Maximum number of cyclic input data	255 bytes/connection
Maximum number of cyclic output data	255 bytes/connection
Maximum Configuration data	1000 bytes/slave
Acyclic communication	Explicit connection All service codes are supported
Connections	Bit Strobe Change of State Cyclic Poll Explicit Peer-to-Peer Messaging
Function	Quick Connect
Fragmentation	Explicit and I/O
UCMM	Supported
Objects	Identity Object (Class Code 0x01) Message Router Object (Class Code 0x02) DeviceNet Object (Class Code 0x03) Connection Object (Class Code 0x05) Acknowledge Handler Object (Class Code 0x06)
Baud rates	125 kBits/s, 250 kBit/s, 500 kBit/s Auto baudrate detection is not supported
Data transport layer	CAN frames
Reference to firmware/stack version	V2.3.x.x

Table 53: Technical data DeviceNet Master protocol

11.2.4 PROFINET IO Controller

Parameter	Description
Maximum number of PROFINET IO Devices	128
Maximum number of total cyclic input data	5712 bytes (including IOxS status bytes)
Maximum number of total cyclic output data	5760 bytes (including IOxS status bytes)
Maximum number of cyclic input data	1440 bytes per device (= IOCR data length including IOxS status bytes)
Maximum number of cyclic output data	1440 bytes per device (= IOCR data length including IOxS status bytes)
Acyclic communication	Read/Write Record Limited to 1392 bytes per telegram Limited to 4096 bytes per request
Alarm processing	yes, but requires handling in host application program
Diagnostic data	One 200 byte buffer per IO device
DCP functions via API	Name Assignment IO-Devices (DCP SET NameOfStation) Set IO-Devices IP (DCP SET IP) Signal IO-Device (DCP SET SIGNAL) Reset IO-Device to factory settings (DCP Reset FactorySettings) Bus scan (DCP IDENTIFY ALL)
Supported Protocols	RTC – Real Time Cyclic Protocol, Class 1 RTA – Real Time Acyclic Protocol DCP – Discovery and configuration Protocol CL-RPC – Connectionless Remote Procedure Call
Context management by CL-RPC	Supported
Minimum cycle time	1 ms Different IO-Devices can be configured with different cycle times
Functions	Fast Startup of PROFINET IO Devices supported
Baud rate	100 MBit/s Full-Duplex mode
Data transport layer	Ethernet II, IEEE 802.3
Configuration file	Maximum 1 MByte
Limitations	RT over UDP not supported Multicast communication not supported DHCP is not supported (neither for PROFINET IO-Controller nor for the IO-Devices) Only one IOCR per IO Device NameOfStation of IO Controller CANNOT be set using the DCP SET NameOfStation service but only at start-up while configuring the IO Controller The buffer for IO-Device diagnosis data will be overwritten in case of multiple diagnostic events. Only one (the last) event is stored at the same time. If a single event produces more than 200 bytes of diagnosis data, only the first 200 bytes will be taken care of. The usable (minimum) cycle time depends on the number of used IO Devices, the number of used input and output data. The cycle-time, the number of configured IO Devices and the amount of IO data depend on each other. For example it is not possible due to performance reasons to have 128 IO Devices communication with cycle-time 1ms. The size of the bus configuration file is limited by the size of the RAM Disk (1 MByte) WriteMultiple-Record service is not supported
Reference to firmware/stack version	V2.7.x.x

Table 54: Technical data PROFINET IO RT Controller

11.2.5 EtherCAT Master

Parameter	Description
Maximum number of EtherCAT slaves	Maximum of 388 slaves, if RCX_GET_SLAVE_HANDLES_REQ service is used for determining number of slaves The number of usable slaves depends on several parameters: the available memory for the configuration file (see 'configuration file' below), used cycle time, frame propagation time
Maximum number of cyclic input data	Appr. 4600 bytes, if no LRW command (Logical Read Write) is used for process data
Maximum number of cyclic output data	Appr. 4600 bytes, if no LRW command (Logical Read Write) is used for process data
Acyclic communication	CoE (CANopen over EtherCAT): SDO, SDOINFO, Emergency FoE (File Access over EtherCAT) Configurable with SYCON.net: CoE If the file ETHERCAT.XML contains the appropriate configuration information (e.g. created with "EtherCAT Configurator"), the CoE function can be used
Mailbox protocols	CoE, FoE
Functions	Distributed Clocks Redundancy Slave diagnostics Bus scan
Minimum bus cycle time	250 µs, depending on the used number of slaves and the used number of cyclic input data and output data.
Topology	Line or ring
Slave station address range	1 – 14335
Data transport layer	Ethernet II, IEEE 802.3, 100 MBit/s, full-duplex
Configuration file (ETHERCAT.XML or CONFIG.NXD)	NHST-T100-EN: Maximum 2 MByte
Synchronization via ExtSync	Supported (not configurable with SYCON.net)
ENI Slave-to-Slave copy infos	Supported (not configurable with SYCON.net)
Hot Connect	Supported (not configurable with SYCON.net)
Limitations	The size of the bus configuration file is limited by the size of the Flash disk (2 MByte) Store-and-forward switches cannot be used within network topology due to hard receive timing model RCX_GET_SLAVE_HANDLES_REQ can only communicate up to 388 slaves Process data is restricted by the dual-port memory to 5760 bytes
Reference to firmware / stack version	V4.4

Table 55: Technical data EtherCAT Master protocol

11.2.6 EtherNet/IP Scanner

Parameter	Description
Maximum number of EtherNet/IP connections	64 connections for implicit and explicit
Maximum number of total cyclic input data	5712 bytes
Maximum number of total cyclic output data	5760 bytes
Maximum number of cyclic input data	504 bytes per slave per telegram
Maximum number of cyclic output data	504 bytes per slave per telegram
IO Connection type	Cyclic, minimum 1 ms (depending on used number of connections and used number of input and output data)
Maximum number of unscheduled data	1400 bytes per telegram
UCMM, Class 3	Supported
Explicit Messages, Client and Server Services	Get_Attribute_Single/All Set_Attribute_Single/All
Quick connect	Supported
Predefined standard objects	Identity Object Message Route Object Assembly Object Connection Manager Ethernet Link Object TCP/IP Object DLR Object QoS Object
Maximal number of user specific objects	20
Topology	Tree, Line, Ring
DLR (Device Level Ring)	Beacon based 'Ring Node'
ACD (Address Conflict Detection)	Supported
DHCP	Supported
BOOTP	Supported
Baud rates	10 and 100 MBit/s
Data transport layer	Ethernet II, IEEE 802.3
Switch function	Integrated
Limitations	CIP Sync Services are not implemented TAGs are not supported
Reference to firmware/stack version	V2.10.x.x

Table 56: Technical data EtherNet/IP Scanner (master) protocol

12 Decommissioning/Disposal

12.1 Putting the device out of operation

NOTICE**Danger of Unsafe System Operation !**

To prevent personal injury or property damage, make sure that the removal of the device from your plant during operation will not affect the safe operation of the plant.

- Disconnect all communication cables from the device.
- Disconnect the power supply plug.
- Remove the device from the DIN rail as described in section *Removing netHOST device from the Top Hat Rail* [▶ page 40].

12.2 Disposal of waste electronic equipment

According to the European Directive 2002/96/EG “Waste Electrical and Electronic Equipment (WEEE)”, waste electronic equipment may not be disposed of as household waste. As a consumer, you are legally obliged to dispose of all waste electronic equipment according to national and local regulations.



Waste electronic equipment**Waste Electronic Equipment**

This product must not be treated as household waste.

This product must be disposed of at a designated waste electronic equipment collecting point.

List of figures

Figure 1:	Data flow of LAN controlled netHOST device.....	23
Figure 2:	netHOST for Fieldbus: NHST-T100-DP/DPM (example)	25
Figure 3:	netHOST for RTE systems	26
Figure 4:	Galvanic isolation of netHOST for Fieldbus systems	36
Figure 5:	Galvanic isolation of netHOST for RTE systems	37
Figure 6:	ComProX start screen	47
Figure 7:	ComProX Connection dialog	47
Figure 8:	ComProX File Explorer	48
Figure 9:	ComProX Download	48
Figure 10:	Choose a file dialog in ComProX.....	48
Figure 11:	Downloaded firmware in Explorer.....	49

List of tables

Table 1:	List of revisions	5
Table 2:	Reference to devices with preloaded firmware	7
Table 3:	Reference to devices for loadable firmware	7
Table 4:	Reference to software.....	8
Table 5:	Reference to drivers	8
Table 6:	Directory of netHOST Solutions DVD	10
Table 7:	Basic documentation for netHOST	11
Table 8:	Additional documentation for netHOST as PROFIBUS DP Master	12
Table 9:	Additional documentation for netHOST as CANopen Master	12
Table 10:	Additional documentation for netHOST as DeviceNet Master	12
Table 11:	Additional documentation for netHOST as PROFINET IO Controller	13
Table 12:	Additional documentation for netHOST as EtherCAT Master	13
Table 13:	Additional documentation for netHOST as EtherNet/IP Scanner	14
Table 14:	Signal words in safety messages on personal injury	21
Table 15:	Safety signs in messages on personal injury.....	21
Table 16:	Signal words in safety messages on property damage	21
Table 17:	Safety signs in safety messages on property damage	21
Table 18:	Dimensioned drawing, example NHST-T100-DP	29
Table 19:	LEDs, connectors and operating elements of netHOST for Fieldbus systems	30
Table 20:	LEDs, connectors and operating elements of netHOST for RTE systems	31
Table 21:	Sticker for NHST-T100-EN	32
Table 22:	Device label (NHST-T100-DP example).....	32
Table 23:	Pin assignment Mini Combicon socket 2-pole	32
Table 24:	Ethernet RJ45 pin assignment.....	33
Table 25:	PROFIBUS RS-485 pin assignment.....	34
Table 26:	CANopen pin assignment.....	34
Table 27:	DeviceNet pin assignment.....	35
Table 28:	Pin assignment Mini-B USB connector (5-pin)	35
Table 29:	Coupling of netHOST for Fieldbus systems.....	36
Table 30:	Coupling of netHOST for RTE systems	37
Table 31:	Mounting the netHOST device onto Top Hat Rail.....	39
Table 32:	Removing the netHOST device from Top Hat Rail	40
Table 33:	netHOST troubleshooting by LED	50
Table 34:	System LED	51
Table 35:	APL LED	52
Table 36:	LED states for the PROFIBUS DP Master protocol	53
Table 37:	LED state definitions for the PROFIBUS DP Master protocol	53
Table 38:	LED states for the CANopen Master protocol.....	54
Table 39:	LED state definitions for the CANopen Master protocol	54
Table 40:	LED states for the DeviceNet Master protocol.....	55

Table 41:	LED state definitions for the DeviceNet Master protocol	55
Table 42:	LED states for the PROFINET IO-Controller protocol	56
Table 43:	LED state definitions for the PROFINET IO-Controller protocol	56
Table 44:	LED states for the EtherCAT Master(V4) protocol.....	57
Table 45:	LED state definitions for the EtherCAT Master(V4) protocol	57
Table 46:	LED states for the EtherNet/IP Scanner protocol	59
Table 47:	LED state definitions for the EtherNet/IP Scanner protocol.....	60
Table 48:	Technical data netHOST for Fieldbus systems (Part 1)	61
Table 49:	Technical data netHOST for Fieldbus systems (Part 2)	62
Table 50:	Technical data netHOST for Real-Time Ethernet systems.....	63
Table 51:	Technical data PROFIBUS DP Master protocol	64
Table 52:	Technical data CANopen Master protocol	65
Table 53:	Technical data DeviceNet Master protocol	66
Table 54:	Technical data PROFINET IO RT Controller	67
Table 55:	Technical data EtherCAT Master protocol.....	68
Table 56:	Technical data EtherNet/IP Scanner (master) protocol	69

Contacts

HEADQUARTER

Germany

Hilscher Gesellschaft für
Systemautomation mbH
Rheinstraße 15
65795 Hattersheim
Phone: +49 (0) 6190 9907-0
Fax: +49 (0) 6190 9907-50
E-mail: info@hilscher.com

Support

Phone: +49 (0) 6190 9907-990
E-mail: hotline@hilscher.com

SUBSIDIARIES

China

Hilscher Systemautomation (Shanghai) Co. Ltd.
200010 Shanghai
Phone: +86 (0) 21-6355-5161
E-mail: info@hilscher.cn

Support

Phone: +86 (0) 21-6355-5161
E-mail: cn.support@hilscher.com

France

Hilscher France S.a.r.l.
69800 Saint Priest
Phone: +33 (0) 4 72 37 98 40
E-mail: info@hilscher.fr

Support

Phone: +33 (0) 4 72 37 98 40
E-mail: fr.support@hilscher.com

India

Hilscher India Pvt. Ltd.
Pune, Delhi, Mumbai, Bangalore
Phone: +91 8888 750 777
E-mail: info@hilscher.in

Support

Phone: +91 8108884011
E-mail: info@hilscher.in

Italy

Hilscher Italia S.r.l.
20090 Vimodrone (MI)
Phone: +39 02 25007068
E-mail: info@hilscher.it

Support

Phone: +39 02 25007068
E-mail: it.support@hilscher.com

Japan

Hilscher Japan KK
Tokyo, 160-0022
Phone: +81 (0) 3-5362-0521
E-mail: info@hilscher.jp

Support

Phone: +81 (0) 3-5362-0521
E-mail: jp.support@hilscher.com

Republic of Korea

Hilscher Korea Inc.
13494, Seongnam, Gyeonggi
Phone: +82 (0) 31-739-8361
E-mail: info@hilscher.kr

Support

Phone: +82 (0) 31-739-8363
E-mail: kr.support@hilscher.com

Austria

Hilscher Austria GmbH
4020 Linz
Phone: +43 732 931 675-0
E-mail: sales.at@hilscher.com

Support

Phone: +43 732 931 675-0
E-mail: at.support@hilscher.com

Switzerland

Hilscher Swiss GmbH
4500 Solothurn
Phone: +41 (0) 32 623 6633
E-mail: info@hilscher.ch

Support

Phone: +41 (0) 32 623 6633
E-mail: support.swiss@hilscher.com

USA

Hilscher North America, Inc.
Lisle, IL 60532
Phone: +1 630-505-5301
E-mail: info@hilscher.us

Support

Phone: +1 630-505-5301
E-mail: us.support@hilscher.com